

---

# Kodak EasyShare Z7590 zoom digital camera



## User's guide

[www.kodak.com](http://www.kodak.com)

For interactive tutorials, [www.kodak.com/go/howto](http://www.kodak.com/go/howto)

For help with your camera, [www.kodak.com/go/z7590support](http://www.kodak.com/go/z7590support)



Eastman Kodak Company  
Rochester, New York 14650  
© Eastman Kodak Company, 2005

All screen images are simulated.

Kodak and EasyShare are trademarks of Eastman Kodak Company.

Schneider-Kreuznach, Xenar, and Variogon are trademarks of Jos. Schneider Optische Werke GmbH used under license by Eastman Kodak Company.

P/N 4J3110

## Top, front view

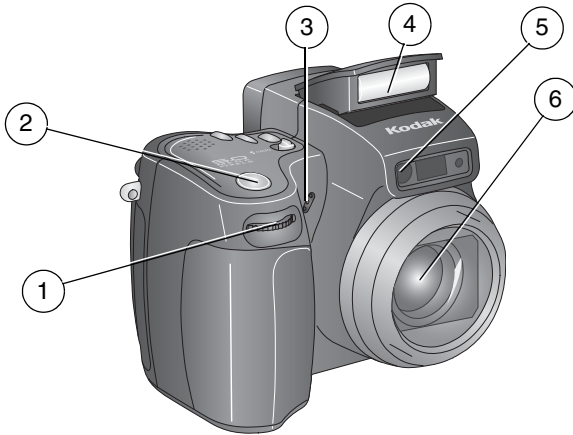

- |   |                |   |                        |
|---|----------------|---|------------------------|
| 1 | Jog dial       | 4 | Flip-up flash          |
| 2 | Shutter button | 5 | Self-Timer/Video light |
| 3 | Microphone     | 6 | Lens                   |

## Side views

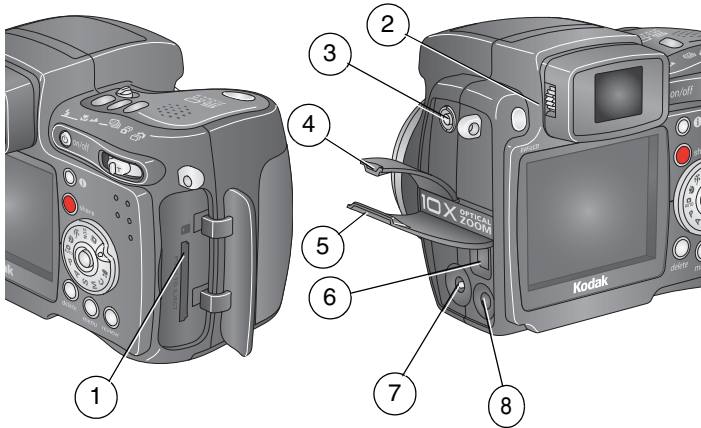

1 SD/MMC card slot

2 Diopter dial

3 External flash connector

4 External-flash-connector cover

5 USB port/ DC-In/ A/V-Out cover

6 USB port 

7 DC-In (5V)

8 A/V Out (for TV viewing)

## Back view

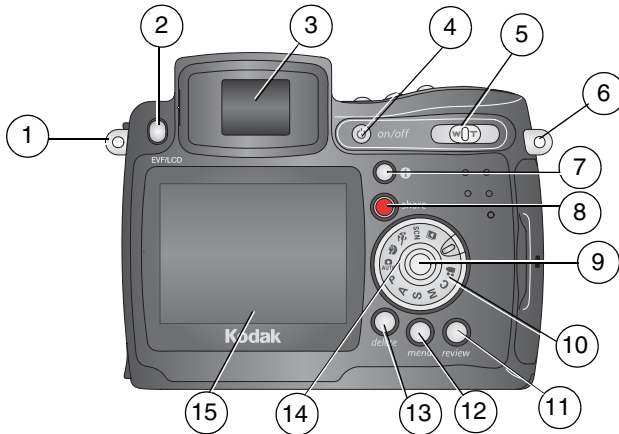





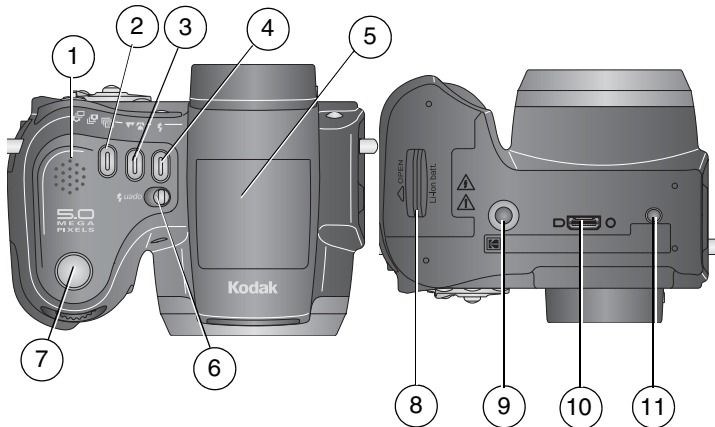

- |   |  |
|---|--|
| 1 Neck strap post   | 10 Mode dial                           |
| 2 EVF/LCD toggle button   | 11 Review button                       |
| 3 EVF (Electronic Viewfinder)   | 12 Menu button                         |
| 4 On/Off button   | 13 Delete button                       |
| 5 Zoom (Wide Angle/Telephoto)   | 14 Power ring                          |
| 6 Neck strap post   | 15 LCD screen (Liquid Crystal Display) |
| 7 Status button <b>i</b>  |  |
| 8 Share button  |  |
| 9 Joystick (move $\leftarrow/\rightarrow$ $\blacktriangle/\blacktriangledown$ );<br>OK button (press) |  |

## Top and bottom views



### Top

- 1 Speaker
- 2 Exposure bracketing  /  
First burst  /Last burst  button
- 3 Close-up  /Landscape  button
- 4 Flash button 
- 5 Flip-up flash
- 6 Open  flash switch
- 7 Shutter button

### Bottom

- 8 Battery door
- 9 Tripod socket/locator for  
EasyShare camera dock or  
printer dock
- 10 Dock connector
- 11 Locator for EasyShare camera  
dock or printer dock

---

# Table of contents

<b>1 Getting started</b> .....	<b>1</b>
Installing the software first .....	1
Charging the battery .....	1
Inserting the battery .....	2
Important battery information .....	2
Battery safety and handling .....	4
Turning the camera on and off .....	5
Setting the language .....	5
Setting the date and time .....	6
Changing the display, EVF or LCD .....	7
Checking camera and picture status .....	7
Storing pictures on a SD or MMC card .....	8
<b>2 Taking pictures and videos</b> .....	<b>9</b>
Taking a picture .....	9
Taking a video .....	14
Quickview—Reviewing the picture or video just taken .....	15
Using optical zoom .....	16
Using advanced digital zoom .....	16
Picture-taking modes .....	17
Using the flip-up flash .....	23
Using an external flash unit .....	27
Shooting close-up and landscape pictures .....	27
Using exposure bracketing .....	28
Using burst .....	29
Changing picture-taking settings .....	30
Using setup to customize your camera .....	36
Putting yourself in the picture or video .....	38
Pre-tagging for album names .....	39
Tips for better pictures .....	40

<b>3</b>	<b>Reviewing pictures and videos</b>	<b>45</b>
	Viewing single pictures and videos	45
	Viewing multiple pictures and videos	47
	Playing a video	47
	Deleting pictures and videos	48
	Magnifying pictures	48
	Changing optional review settings	49
	Protecting pictures and videos from deletion	49
	Viewing picture/video information	50
	Tagging pictures/videos for albums	50
	Running a slide show	51
	Displaying pictures and videos on a television	52
	Copying pictures and videos	53
<b>4</b>	<b>Installing the software</b>	<b>54</b>
	Install the software	55
<b>5</b>	<b>Sharing pictures and videos</b>	<b>56</b>
	When can I tag my pictures and videos?	56
	Tagging pictures for printing	57
	Tagging pictures and videos for emailing	58
	Tagging pictures as favorites	59
<b>6</b>	<b>Transferring and printing pictures</b>	<b>62</b>
	Transferring pictures/videos with the USB cable	62
	Printing from a Kodak EasyShare printer dock or your computer	63
	Printing from an optional SD or MMC card	63
	Ordering prints online	63
	Direct printing with a PictBridge-enabled printer	64
	Dock compatibility for your camera	66



---

<b>7 Troubleshooting</b> .....	<b>67</b>
Camera problems.....	67
Computer/connectivity problems.....	70
Picture quality problems .....	70
Power-ring-light status.....	72
Direct printing (PictBridge) problems.....	73
<b>8 Getting help</b> .....	<b>74</b>
Helpful links.....	74
Telephone customer support .....	75
<b>9 Appendix</b> .....	<b>76</b>
Camera specifications .....	76
Storage capacities.....	79
Power-saving features.....	81
Accessories .....	82
Upgrading your software and firmware.....	83
Additional care and maintenance .....	83
Warranty.....	84
Regulatory compliance .....	86



# 1

## Getting started

### Installing the software first

**IMPORTANT:** *Install the software from the Kodak EasyShare software CD before connecting the camera (or dock) to the computer. Otherwise, the software may install incorrectly. See the Start Here! guide or [Install the software, page 55](#).*

### Charging the battery

The Li-Ion rechargeable battery requires charging before first use.

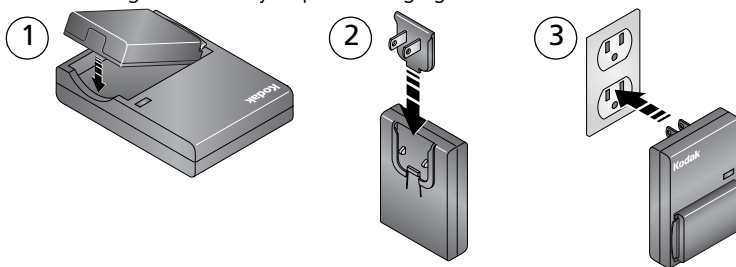

- 1 Insert the battery into the charger.
- 2 Insert the plug that matches your electrical outlet.
- 3 Plug the charger into the outlet.

*The indicator light turns red. When the indicator light turns green, remove the battery and unplug the charger. Charging takes approximately 3 hours.*

You can also charge the battery using an optional Kodak EasyShare printer dock or camera dock. Purchase these and other accessories at a dealer of Kodak products or visit [www.kodak.com/go/z7590accessories](http://www.kodak.com/go/z7590accessories).

## Inserting the battery



### CAUTION:

Use only a Kodak EasyShare Li-Ion rechargeable battery.

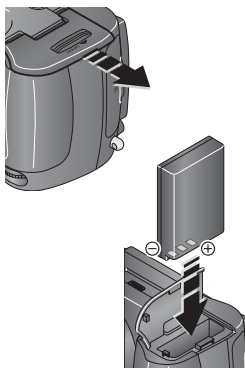

- 1 Make sure the camera is turned off.
- 2 On the bottom of the camera, slide the battery door and lift to open.
- 3 Insert the battery as shown. Push the battery completely into the battery compartment.
- 4 Close the battery door.

## Important battery information

### Kodak battery replacement types/battery life

Actual battery life may vary based on usage.

Li-Ion rechargeable battery,  
1700 mAh (KLIC 5001)  
(included with camera)

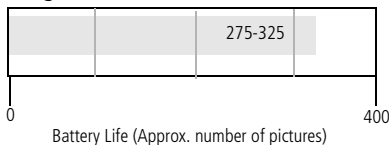

We recommend using only a Kodak EasyShare Li-Ion rechargeable battery. Not all manufacturers' 3.7V Li-Ion rechargeable batteries are compatible with the camera. Damage caused by unauthorized accessories is not covered under warranty.

Optional battery: You can use a Kodak EasyShare Li-Ion rechargeable battery, 1050 mAh, but it is a lower power battery. Expect approximately 30% fewer pictures per full charge than with the 1700 mAh battery included with your camera.

## Extending battery life

- Limit the following activities that deplete battery power:
  - Using Quickview ([page 15](#))
  - Excessive use of the flash
  - Using the LCD screen; utilize the EVF screen instead.
- Dirt on the battery contacts can affect battery life. Wipe the contacts with a clean, dry cloth before inserting a battery in the camera.
- Battery performance is reduced at temperatures below 41° F (5° C). When using your camera in cold weather, carry spare batteries and keep them warm. Do not discard cold batteries that do not work; when they return to room temperature, they may be usable.

Visit [www.kodak.com/go/z7590accessories](http://www.kodak.com/go/z7590accessories) for:

**Kodak EasyShare camera dock**—powers your camera, transfers pictures to your computer, and charges your battery.

**Kodak EasyShare printer dock**—powers your camera, makes 4 x 6 in. (10 x 15 cm) prints with or without a computer, transfers pictures, and charges your battery.

**Kodak 5-volt AC adapter**—powers your camera.

## Battery safety and handling



### CAUTION:

**When removing batteries, allow them to cool first; batteries may be hot.**

- Read and follow all warnings and instructions supplied by the battery manufacturer.
- Use only batteries that are approved for this product.
- Keep batteries out of the reach of children.
- Do not allow batteries to touch metal objects, including coins. Otherwise, a battery may short circuit, discharge energy, become hot, or leak.
- Do not disassemble, install backward, or expose batteries to liquid, moisture, fire, or extreme temperature.
- Remove battery when the product is stored for an extended period of time. In the unlikely event that battery fluid leaks inside the product, contact your local Kodak Customer Service representative.
- In the unlikely event that battery fluid leaks onto your skin, wash immediately with water and contact your local health provider. For additional health-related information, contact your local Kodak Customer Service representative.
- Dispose of batteries according to local and national regulations.
- Do not charge non-rechargeable batteries.

## Turning the camera on and off

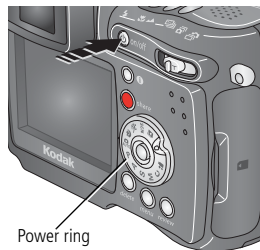

- Press the On/Off button.



*Your camera is ready to take pictures when the Power ring stops blinking.*

*The EVF or the LCD screen turns on, depending on which display was last used.*

- Press the On/Off button to turn off the camera.

*The camera completes operations that are in process.*

## Setting the language

- 1 Turn on the camera. Press the Menu button.
- 2 Move the Joystick ▲/▼ to highlight Setup Menu , then press the OK button.
- 3 Move the Joystick ▲/▼ to highlight Language , then press the OK button.
- 4 Move the Joystick ▲/▼ to choose a language: English, German, Spanish, French, Italian, Portuguese, Chinese, Korean, or Japanese.
- 5 When finished, press the OK button.
- 6 Press the Menu button to exit the menu.







## Setting the date and time

### Setting the date & time, first time

The message *Date and Time have been reset* appears the first time you turn on the camera or if the battery is removed for an extended time.

- 1 SET DATE & TIME is highlighted. Press the OK button.
- 2 Go to step 4 in [Setting the date & time, anytime](#).

### Setting the date & time, anytime

- 1 Turn on the camera. Press the Menu button.
- 2 Move the Joystick  to highlight Setup Menu , then press the OK button.
- 3 Move the Joystick  to highlight Date & Time , then press the OK button.
- 4 Move the Joystick  to adjust the date and time. Move the Joystick  to advance to the next setting.
- 5 When finished, press the OK button.
- 6 Press the Menu button to exit the menu.

NOTE: Depending on your computer operating system, Kodak EasyShare software may update the camera clock when you connect the camera. See the EasyShare software Help for details.



## Changing the display, EVF or LCD

Your camera has an Electronic Viewfinder (EVF). The EVF, like the LCD (Liquid Crystal Display) screen, displays what the camera captures.

EVF/LCD  
toggle  
button



Press the EVF/LCD toggle button to change the screen from EVF to LCD, and back.

*The selection remains until you press the button again.*

**NOTE:** The EVF/LCD screen turns off after 1 minute if no pictures are taken. Press any button to turn the display back on.

## Using the diopter dial

You can adjust the EVF sharpness for your eyesight.

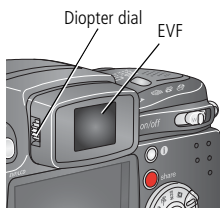

- Look through the EVF.
- Turn the Diopter dial until the viewfinder image is sharp.

## Checking camera and picture status

The icons that appear on the EVF/LCD screen indicate the active camera and picture settings.



Press the Status **i** button to turn the icons off and on.

## Storing pictures on a SD or MMC card

Your camera has 32 MB of internal memory. You can purchase optional SD cards at a dealer of Kodak products or at [www.kodak.com/global/en/digital/accessories](http://www.kodak.com/global/en/digital/accessories) for removable, reusable storage for your pictures and videos.

NOTE: We recommend Kodak SD or MMC cards. Other SD brands are acceptable, but must possess the SD  logo. (The SD logo is a trademark of the SD Card Association.) When using the card for the first time, format it in this camera before taking pictures (see [page 38](#)).



### CAUTION:

**The card can only be inserted one way; forcing it may damage the camera or card. Do not insert or remove a card when the green ready light is blinking; doing so may damage your pictures, card, or camera.**

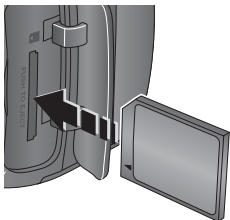

- 1 Turn off the camera, then open the card door.
- 2 Orient the card as shown on the camera body.
- 3 Push the card all the way into the slot.
- 4 Close the door.

To remove the card, turn off the camera. Push the card in, then release it. When the card is partially ejected, pull it out.

See [page 79](#) for storage capacities.

## 2

# Taking pictures and videos

## Taking a picture

The camera is always ready to take pictures—in Review, Share, or Setup but not in Favorites. (In Video mode, the camera captures video.)

- 1 Press the On/Off button.
- 2 Turn the Mode dial to the desired setting.

NOTE: Use Auto  for general picture-taking situations. (See [page 17](#) for other camera-mode options.)

- 3 Use the EVF or LCD screen to frame your subject. (Press the EVF/LCD toggle button to switch to the other. See [page 7](#).)

*The EVF/LCD screen displays a mode description and a live view.*

NOTE: To take flash pictures, open the flip-up flash (see [page 20](#)). An Open Flash warning appears on the EVF/LCD screen when the flash unit needs to be open.

- 4 Press the Shutter button **halfway** to set the Auto Focus (AF) and Auto Exposure (AE).

*The AF/AE indicator is displayed. If the focus and/or exposure fails, recompose the shot and try again.*

- 5 Continue pressing the Shutter button **completely down** to take the picture.



## Using the auto-focus framing marks

When using the camera EVF/LCD screen as a viewfinder, framing marks indicate where the camera is focusing. For the best pictures, the camera attempts to focus on foreground subjects, even if the subjects are not centered in the scene.

### 1 Press the Shutter button **halfway and hold**.

*When the framing marks turn from blue to green, focus is accomplished.*

While the shutter button is pressed halfway:	
	Center focus
	Center wide focus
	Side focus
	Center and side focus
	Left and right focus

- If the camera is not focusing on the desired subject (or if the framing marks disappear), release the Shutter button and recompose the scene.
- Press the Shutter button **completely down** to take the picture.

NOTE: Framing marks do not appear in Landscape or Video mode. When you use Focus Zone (page 33) and set Center Zone, the framing marks are fixed at Center Wide.

## Capture modes

Only active camera settings are displayed:

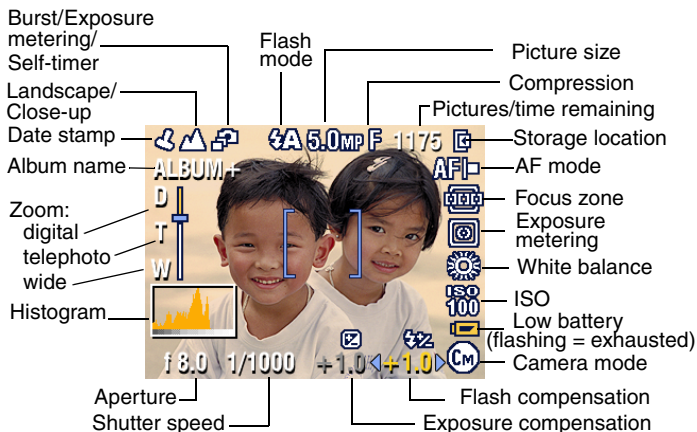

NOTE: A histogram shows the distribution of the subject's brightness. If the peak is to the far right of the graph, the subject is too bright; if it is to the left, it is too dark. Optimal exposure is achieved when the peak is in the middle of the histogram.

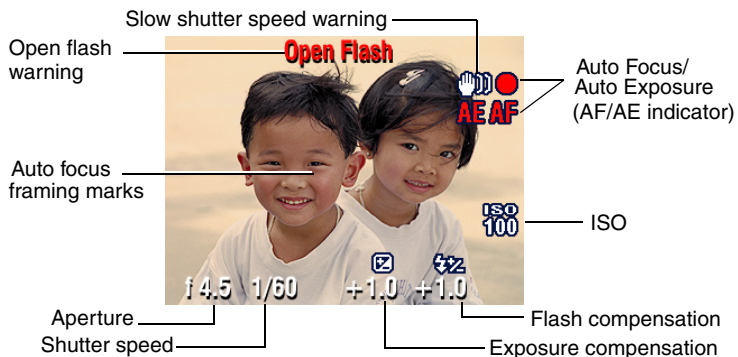

## Capture modes—shutter pressed halfway

Press the Shutter button halfway to display the active manual settings:



## Taking a video

NOTE: You can change optical zoom before (but not during) video recording.

- 1 Turn the Mode dial to Video .
- 2 Press the Menu button. Move the Joystick  to highlight Video Size, then press the OK button.
- 3 Move the Joystick  to highlight the desired Size, then press the OK button.
- 4 To eliminate camera noise during recording, turn off Continuous AF (see [page 34](#)).
- 5 Use the EVF or LCD screen to frame your subject. (Press the EVF/LCD toggle button to switch to the other screen, see [page 7](#).)
- 6 Press the Shutter button completely down and release. To stop recording, press and release the Shutter button again.

*During recording, REC blinks on the screen and the elapsed time is displayed.*

NOTE: If you prefer, press the Shutter button completely down and hold it for more than 2 seconds to begin recording. To stop recording, release the Shutter button. Recording also stops if the storage location is full. See [page 81](#) for video storage capacities.



## Quickview—Reviewing the picture or video just taken

After you take a picture or video, the EVF or LCD screen displays a Quickview for approximately 5 seconds. While the picture or video is displayed, you can:



- **Review:** If you take no action, the picture/video is saved.
- **Play (video):** Press the OK button to play the video. Move the Joystick ▲/▼ to adjust the volume. Press OK again to pause the video.
- **Share:** Press the Share button to tag a picture/video for email (see [page 58](#)) or as a favorite, or to tag a picture for print. (See [page 57](#).)
- **Delete:** Press the Delete button while the picture/video and  are displayed.

**NOTE:** Only the final picture of exposure bracketing (see [page 28](#)) or burst series (see [page 29](#)) is displayed during Quickview. If you select Delete, all pictures in the burst series are deleted. To delete selectively, do so in Review (see [page 48](#)).

## Using optical zoom

Use optical zoom to get up to 10X closer to your subject. Optical zoom is effective when the lens is no closer than 2 ft (0.6 m) from the subject. (See Tips for better pictures on [page 40](#).) You can change optical zoom before (but not during) video recording.

**IMPORTANT:** Place the camera on a sturdy surface or tripod when you take high-zoom pictures.

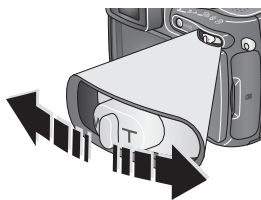

Zoom indicator

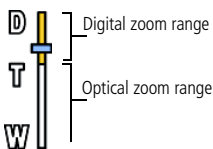

- 1 Use the EVF or LCD screen to frame your subject.
- 2 Push the Zoom button toward Telephoto (T) to zoom in. Push it toward Wide Angle (W) to zoom out.

*The EVF or LCD screen displays the zoomed image and the zoom indicator.*

- 3 Press the Shutter button **halfway and hold** to set the exposure and focus, then press **completely down** to take the picture. (When taking videos, press and release the Shutter button.)

## Using advanced digital zoom

Use advanced digital zoom in any Still mode to get an additional 3X magnification beyond optical zoom; available settings are from 12X to 30X.

**IMPORTANT:** Place the camera on a sturdy surface or tripod when you take high-zoom pictures.

- 1 Push the Zoom button to the telephoto optical zoom limit (10X). Release the button, then push it again.

*The EVF or LCD screen displays the zoomed image and the zoom indicator.*

- 2 Press the Shutter button **halfway and hold** to set the exposure and focus, then press **completely down** to take the picture.

NOTE: You cannot use digital zoom for video recording.

**IMPORTANT:** *You may notice a decrease in printed image quality when using digital zoom. The slider on the zoom indicator pauses, then turns red when the picture size is approximately 1 MP. For an acceptable 4 x 6 in. (10 x 15 cm) print, ensure that the slider remains blue.*



## Picture-taking modes





Mode dial





Choose the mode that best suits your subjects and surroundings.



Use this mode	For
 <b>Auto</b>	General picture-taking—offers an excellent balance of image quality and ease of use.
<b>P</b> <b>Program</b>	Controlling exposure compensation (how much light enters the camera) and flash compensation. The camera automatically sets the shutter speed and aperture (f-stop) based on the scene lighting. Program mode offers the ease of auto shooting with full access to all menu options. Use the jog dial to select settings. (See <a href="#">P, A, S, M, and C modes</a> , <a href="#">page 21</a> .) Press the Menu button to change other settings.









Use this mode	For
<b>A</b> Aperture Priority	Controlling aperture, exposure compensation, flash compensation, and ISO speed. Aperture priority mode is primarily used to control depth of field (the range of sharpness). NOTE: The aperture setting may be affected when using optical zoom. Use the jog dial to select settings. (See <a href="#">P, A, S, M, and C modes, page 21.</a> ) Press the Menu button to change other settings.
<b>S</b> Shutter Priority	Controlling the shutter speed, exposure compensation, flash compensation, and ISO speed. The camera automatically sets the aperture for proper exposure. Shutter priority mode is primarily used to prevent blur when your subject is moving. To prevent camera shake, use a tripod for slow shutter speeds. Use the jog dial to select settings. (See <a href="#">P, A, S, M, and C modes, page 21.</a> ) Press the Menu button to change other settings.
<b>M</b> Manual	Enjoying the highest level of creative control. You set the aperture, flash compensation, shutter speed and ISO speed. Exposure compensation acts as an exposure meter, recommending the proper combination of aperture and shutter speed to produce an acceptable exposure. To prevent camera shake, use a tripod for slow shutter speeds. Use the jog dial to select settings. (See <a href="#">P, A, S, M, and C modes, page 21.</a> ) Press the Menu button to change other settings.
<b>C</b> Custom	The "user-created" mode. For applying P, A, S, M plus any Custom settings (exposure compensation, flash compensation, ISO speed) which are saved independent of other camera settings. Use the jog dial to select settings. (See <a href="#">P, A, S, M, and C modes, page 21.</a> ) Press the Menu button to choose a capture mode. (See <a href="#">Custom Exposure Mode, page 30.</a> ) Press the Menu button to change other settings.
 Video	Capturing video with sound. (See <a href="#">page 14.</a> )
 Favorites	Viewing your favorites. (See <a href="#">page 59.</a> )



Use this mode	For
<b>SCN</b> Scene	Point-and-shoot simplicity when taking pictures under 14 special conditions. (See <a href="#">Scene modes</a> , page 19.)
 Sport	Subjects that are in motion. Shutter speed is fast. The camera pre-settings are f/2.8–f/3.7, Multi-Pattern Exposure Metering, Multi-Zone Focus, ISO 100–ISO 200.
 Portrait	Full-frame portraits of people. Allows the subject to be sharp and the background to be indistinct. For best results, position your subject at least 6 ft (2 m) away and fill the frame with a head and shoulder pose. Use Telephoto to exaggerate background blur. The camera pre-settings are f/2.8–f/3.7, Multi-Pattern Exposure Metering, Multi-Zone Focus, ISO 100.

## Scene modes

- 1 Turn the Mode dial to Scene **SCN**.
  - 2 Move the Joystick     to display Scene mode descriptions.
- NOTE: If the screen turns off, press the OK button.
- 3 Press the OK button to choose a Scene mode.

Use this SCN mode	For	Camera pre-settings
 <b>Close-up</b>	Subjects closer than 28 in. (70 cm).	f/2.8–f/3.7, Macro Focus, Center-Weight Metering, Center-Zone Focus, ISO 100
 <b>Landscape</b>	Distant scenery. Flash does not fire. Auto-focus framing marks ( <a href="#">page 11</a> ) are not available in Landscape.	f/2.8–f/3.7, Infinity Focus, Multi-Pattern Exposure Metering, Daylight White Balance, ISO 100
 <b>Night Portrait</b>	Reduces red eye of people in night scenes or low-light conditions. Place the camera on a flat, steady surface or use a tripod.	f/2.8–f/3.7, Multi-Pattern Exposure Metering, Multi-Zone Focus, ISO 140

Use this SCN mode		For	Camera pre-settings
	<b>Night Landscape</b>	Distant scenery at night. Flash does not fire. Place the camera on a flat, steady surface or use a tripod.	f/2.8–f/3.7, Infinity Focus, Daylight White Balance, Center-Weight Metering, ISO 100
	<b>Snow</b>	Bright snow scenes.	f/2.8–f/3.7, +1 Exposure Compensation, Center-Weight Metering, Multi-Zone Focus, ISO 100
	<b>Beach</b>	Bright beach scenes.	f/2.8–f/3.7, +1 Exposure Compensation, Center-Weight Metering, Daylight White Balance, ISO 100
	<b>Text</b>	Documents.	f/2.8–f/3.7, Macro Focus, +1 Exposure Compensation, Center-Weight Metering, ISO 140
	<b>Fireworks</b>	Flash does not fire. Place the camera on a flat, steady surface or use a tripod.	f/5.6, 2 second exposure, Infinity Focus, Center-Weight Metering, Daylight White Balance, ISO 100
	<b>Flower</b>	Close-ups of flowers or other small subjects in bright light.	f/2.8–f/3.7, Macro Focus, Daylight White Balance, Center-Zone Focus, Center-Weight Metering, ISO 140
	<b>Manner/ Museum</b>	Quiet occasions, like a wedding or lecture. Flash and sound are disabled.	f/2.8–f/3.7, no sounds, no flash, Multi-Pattern Exposure Metering, Multi-Zone Focus, ISO 100
	<b>Self-Portrait</b>	Close-ups of yourself. Assures proper focus and minimizes red eye.	f/2.8, Macro Focus, Multi-Pattern Exposure Metering, Multi-Zone Focus, Red-Eye Flash, ISO 100
	<b>Party</b>	People indoors. Minimizes red eye.	f/2.8–f/3.7, Multi-Pattern Exposure Metering, Multi-Zone Focus, Red-Eye Flash, ISO 140

Use this SCN mode		For	Camera pre-settings
	<b>Children</b>	Action pictures of children in bright light.	f/2.8–f/3.7, Multi-Pattern Exposure Metering, Multi-Zone Focus, ISO 140
	<b>Backlight</b>	Subjects that are in shadow or “backlit” (when light is behind the subject).	f/2.8–f/3.7, Multi-Pattern Exposure Metering, Multi-Zone Focus, Fill-Flash, ISO 100

## P, A, S, M, and C modes

Settings you change in P, A, S or M modes apply only to pictures taken in those modes. Settings you change in C mode apply only to pictures taken in that mode.

For example, if you change the Color Mode to Sepia while in P, A, S, or M mode, you still retain the default setting of Color for Auto and Scene modes.

NOTE: The settings, including Flash, are maintained for P, A, S, M, and C modes—even when you change modes or turn off the camera. Use Reset to Default (see [page 34](#)) to reset P, A, S, M, or C mode to its default setting.

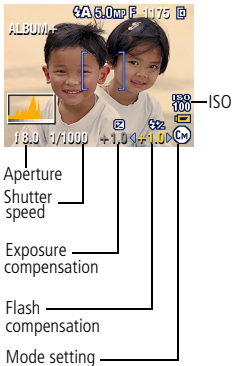

**Aperture**—also known as f-stop, controls the size of the lens opening, which determines the depth of field. Smaller f-numbers, for example f/2.8, refers to a bigger lens opening. Larger f-numbers, for example f/8, refers to a smaller lens opening.

Larger f-numbers keep the main subject sharp; good for landscapes and well-lit conditions. Smaller f-numbers are good for portraits and low-light conditions. The highest and lowest aperture numbers may be affected by optical zoom.

**Shutter speed**—controls how long the shutter stays open. A shaking hand icon  warns of slow shutter speeds. (Use a tripod for slow shutter speeds.)

**Exposure Compensation**—allows the user to manually adjust the exposure; good for controlling backlit or non-standard scenes. If the picture is too light, decrease the setting; if it's too dark, increase the setting.

**Flash Compensation**—controls the flash brightness (+0.5, +1.0, -0.5, -1.0). You must be within flash range. Unavailable if flash setting is Off.

**ISO**—controls sensitivity of the camera sensor (80, 100, 200, 400, 800). Higher settings are more sensitive to light, but may produce unwanted “noise” in a picture. You can only use ISO 800 if you are in the 1.8 MP Picture Size setting. (See [Picture Size, page 31.](#))

See Tips for better pictures on [page 40.](#)

## Using the jog dial to change P, A, S, M, or C mode settings

The Jog dial controls the f-number, shutter speed, exposure and flash compensations, and ISO. Use the Menu button to control all other settings.

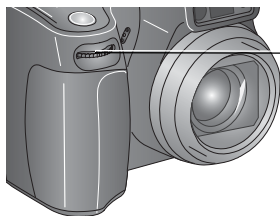

Jog dial:

- Rotate to move the cursor or change settings.
- Press to open or save settings.

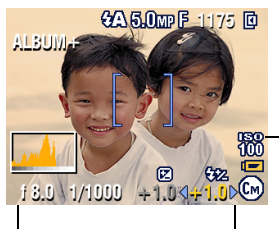

P, A, S, M, or C mode options



White—selectable

Grey—non-selectable

Yellow—changeable value

Red—out of range



- 1 Turn the Mode dial to P, A, S, M, or C.  
*The mode options are displayed.*
- 2 Use the Jog dial:
  - Rotate the Jog dial to move the cursor  between the available settings.
  - Press the Jog dial to open a setting.
  - Rotate the Jog dial to change the setting  +1.0 .
  - Press the Jog dial to save the setting.
- 3 Press the Menu button to change other settings (see [page 30](#)).
- 4 Take a picture.

## Using the flip-up flash

Use the flash when you take pictures at night, indoors, or outdoors in heavy shadows. You can change the flash setting in most Still modes, except Burst; the default setting is restored when you exit the mode or turn off the camera.

### Turning on the flash



open  switch

Slide the open flash switch to raise the flash and to turn it on.

NOTE: The flash unit must be open to use the flash and to change the flash modes. An Open Flash warning appears on the EVF/LCD screen when the flash unit needs to be open.

## Changing the flash settings

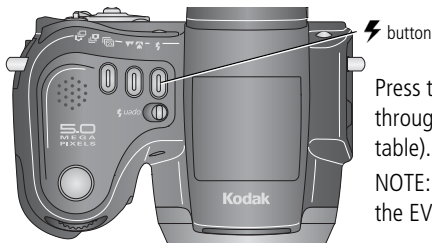





Press the flash button repeatedly to scroll through the flash modes (see Flash modes table).

NOTE: The active flash icon is displayed in the EVF/LCD screen status area.

Flash-to-subject distance	
Zoom position	Flash distance
Wide angle	2–16.1 ft (0.6–4.9 m) @ ISO 140
Telephoto	6.6–12.1 ft (2.0–3.7 m) @ ISO 140

Flash-icon behavior	Cause	Action
Blinking 	Flash is charging.	Wait. Take picture when the icon stops blinking.
	Flash button is pressed, flash unit is closed.	Open flash unit or take the picture without flash.







Flash modes	Flash fires
 <b>Auto Flash</b>	When the lighting conditions require it.
 <b>Fill</b>	Every time you take a picture, regardless of the lighting conditions. Use when the subject is in shadow or is “backlit” (when the light is behind the subject). In low light, hold the camera steady or use a tripod. See Tips for better pictures on <a href="#">page 40</a> .















	<b>Red-eye</b>	Once, so the subject's eyes become accustomed to the flash, then fires again when the picture is taken. (If the lighting conditions require flash but do not require Red-eye reduction, the flash may fire only once.)
	<b>Off</b>	Never

NOTE: Rear-curtain-flash sync activates automatically when the flash is fired and the shutter speed is set at 1/30 second or longer. The flash fires just before the shutter closes to create a stream-of-light effect behind a moving object for a more natural appearance. This feature prevails only in S, M, and C and in Night portrait mode.

## Flash settings in each mode

Flash settings are pre-set for each picture-taking mode.

Capture modes		Default setting	Available settings
	<b>Auto</b>	Auto*	Auto, Off, Fill Flash, Red-eye
	<b>Portrait</b>	Auto*	Auto, Off, Fill Flash, Red-eye
	<b>Sport</b>	Auto*	Auto, Off, Fill Flash, Red-eye
<b>P, A, S, M, C</b>	<b>P, A, S, M, or C</b>	Auto*	Auto, Off, Fill Flash, Red-eye
SCN Scene modes			
	<b>Close-up</b>	Off	Auto, Off, Fill Flash
	<b>Landscape</b>	Off	Off
	<b>Night Portrait</b>	Red-eye*	Auto, Off, Fill Flash, Red-eye
	<b>Night Landscape</b>	Off	Off

Capture modes		Default setting	Available settings
	<b>Snow</b>	Auto*	Auto, Off, Fill Flash, Red-eye
	<b>Beach</b>	Auto*	Auto, Off, Fill Flash, Red-eye
	<b>Text</b>	Off	Auto, Off
	<b>Fireworks</b>	Off	Off
	<b>Flower</b>	Off	Auto, Off, Fill Flash
	<b>Manner/Museum</b>	Off	Off
	<b>Self-Portrait</b>	Red-eye*	Auto, Off, Fill Flash, Red-eye
	<b>Party</b>	Red-eye*	Auto, Off, Fill Flash, Red-eye
	<b>Children</b>	Auto*	Auto, Off, Fill Flash, Red-eye
	<b>Backlight</b>	Fill	Fill
	<b>Video</b>	Off	Off
	<b>First burst</b>	Off	Off
	<b>Last burst</b>	Off	Off
	<b>Exposure bracketing</b>	Off	Off

\* When you change to Auto or Red-eye in these modes, it becomes the default until you change it.

## Using an external flash unit

Use an external flash unit when you want additional or specialized lighting. You can use the camera's built-in flash, as well, to provide extra fill flash.

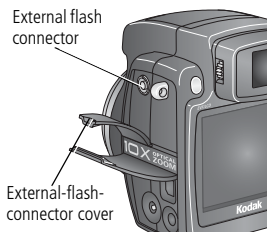

- 1 Turn off the camera and flash unit.
- 2 Open the External-flash-connector cover.
- 3 Plug your external-flash-unit cable into the External flash connector on the camera.



*The external flash unit is live when connected to the camera. The flash synchronizes at any shutter speed. Refer to your external flash unit user's guide for details.*

NOTE: The connector accepts all standard external flash cables, maximum 500 volts.

## Shooting close-up and landscape pictures

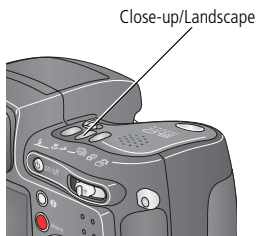
Use the Close-up/Landscape button  to take pictures of scenes that are very close or very far away. (Not available in Scene modes.)



- 1 Set the Mode dial to any Capture mode.
- 2 Press the Close-up/Landscape  button repeatedly until the  or  icon appears in the status bar.
- 3 Take a picture.

## Close-up pictures

Use the Close-up setting  to gain sharpness and detail in pictures at close range. Use available light instead of flash if possible. The camera automatically sets the focus distance depending on the zoom position:

Zoom position	Close-up distance
Wide angle	4.7 to 27.6 in. (0.12 to 0.7 m)
Telephoto	3.9 to 6.9 ft (1.2 to 2.1 m)

See Tips for better pictures on [page 40](#).

## Landscape pictures

Use the Landscape setting  to gain maximum sharpness of far away scenes. With this setting, the camera uses infinity auto-focus. Auto-focus framing marks (see [page 11](#)) are not available in Landscape.

## Using exposure bracketing

Option	Description	Purpose
 <b>Exposure Bracketing</b>	The camera takes 3 pictures — one at +, one at 0, and one at –exposure.	Determine the best exposure level for your conditions based on your evaluation of 3 pictures.

- 1 Set the exposure bracketing interval. (See [Exposure Bracketing Interval, page 32](#).)
- 2 In most Still modes, press the Exposure bracketing button repeatedly to choose .
- 3 Press the Shutter button **halfway and hold** to set the auto focus and exposure.
- 4 Press the Shutter button **completely down** to take the pictures.



*The camera takes 3 pictures. To evaluate them, press the Review button. Exposure bracketing turns off after the pictures are taken.*

## Using exposure compensation with exposure bracketing

In P, A, and S modes, you can use exposure compensation in conjunction with exposure bracketing.

If exposure compensation is set to	And if the exposure bracketing interval is set to	Then the exposures taken are
0.0	the default +/-0.3	-0.3, 0.0, +0.3
+1.0		+0.7, +1.0, +1.3
-1.0		-1.3, -1.0, -0.7

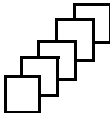
## Using burst

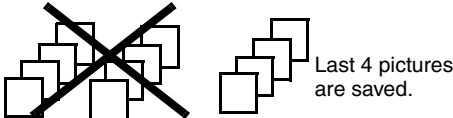
Option	Description	Purpose
 <b>First Burst</b>	<p>Camera takes up to 5 pictures (2 per second) while the Shutter button is pressed.</p>  <p>First 5 pictures are saved.</p>	<p>Capture an expected event.</p> <p><b>Example:</b> A person swinging a golf club.</p>
 <b>Last Burst</b>	<p>Camera takes up to 30 pictures (2 per second for up to 15 seconds) while the Shutter button is pressed. When the Shutter button is released, only the last 4 pictures are saved.</p>  <p>Last 4 pictures are saved.</p>	<p>Capture an event when the precise timing is uncertain.</p> <p><b>Example:</b> A child blowing out birthday candles.</p>

- 1 In most Still modes, press the Burst button repeatedly to choose an option.
- 2 Press the Shutter button **halfway and hold** to set the auto focus and exposure.
- 3 Press the Shutter button **completely down and hold it** to take the pictures.





*The camera stops taking pictures when you release the Shutter button, when the pictures are taken, or when there is no more storage space.*

NOTE: The EVF/LCD screen will not display during burst.



## Changing picture-taking settings







You can change settings to get the best results from your camera:









- 1 Turn the Mode dial to the desired mode.
- 2 Press the Menu button. (Some settings are unavailable in some modes.)
- 3 Move the Joystick  to highlight a setting, then press the OK button.
- 4 Choose an option, then press the OK button.
- 5 Press the Menu button to exit.







Setting	Icon	Options and icons that appear in Liveview
<p><b>Custom Exposure Mode</b> Choose a preferred capture mode. (See <a href="#">Custom</a>, page 18.) <i>This setting remains until you change it.</i></p>	<p><b>P</b> <b>ASM</b></p>	<p><b>Program (default)</b>   <b>Aperture Priority</b>   <b>Shutter Priority</b>   <b>Manual</b>                       Available only in Custom (C) mode.</p>
<p><b>Self-Timer</b> Turn the Self-Timer on or off. <i>This setting remains until you take the picture, turn the Mode dial, or turn off the camera.</i></p>		<p><b>On</b> <b>Off (default)</b></p>









Setting	Icon	Options and icons that appear in Liveview
<p><b>Picture Size</b> Choose a picture resolution. <i>This setting remains until you change it.</i></p>		<p><b>5.0 MP (default)</b>—for printing up to 20 x 30 in. (51 x 76 cm); pictures are highest resolution and largest file size.</p> <p><b>4.4 MP (3:2)</b>— ideal for printing 4 x 6 in. (10 x 15 cm) prints without cropping. Also for printing up to 20 x 30 in. (51 x 76 cm)</p> <p><b>4.0 MP</b>— for printing up to 20 x 30 in. (51 x 76 cm); pictures are medium resolution with smaller file size.</p> <p><b>3.1 MP</b>—for printing up to 11 x 14 in. (28 x 36 cm); pictures are medium resolution with smaller file size.</p> <p><b>1.8 MP</b>—for printing 4 x 6 in. (10 x 15 cm) prints, emailing, Internet, screen display, or for conserving space.</p>
<p><b>Compression</b> Choose a compression. <i>This setting remains until you change it. The setting is displayed in the status area as "S" or "F."</i></p>	<p>JPG</p>	<p><b>Standard (default)</b> </p> <p><b>Fine</b> </p> <p>NOTE: The Fine setting renders a larger file size.</p>

Setting	Icon	Options and icons that appear in Liveview
<p><b>White Balance</b></p> <p>Choose your lighting condition. <i>The EVF/LCD screen displays the chosen White Balance. This setting remains until you change it.</i></p>		<p><b>Auto (default)</b> —automatically corrects white balance. Ideal for general picture-taking.</p> <p><b>Daylight</b> —for pictures in natural lighting.</p> <p><b>Tungsten</b> —corrects the orange cast of household light bulbs. Ideal for indoor pictures under tungsten or halogen lighting without flash.</p> <p><b>Fluorescent</b> —corrects the green cast of fluorescent lighting. Ideal for indoor pictures under fluorescent lighting without flash.</p> <p><b>Open Shade</b> —for pictures in the shade in natural lighting.</p> <p>Unavailable in Auto, Scene, or Video modes.</p>
<p><b>Exposure Bracketing Interval</b></p> <p>Choose an exposure bracketing interval. <i>P, A, S, M, C: This setting remains until you change it or take pictures. Auto, Scene: This setting remains until you turn the Mode dial or turn off the camera.</i></p>		<p><b>+/- 0.3 EV (default)</b></p> <p><b>+/- 0.7 EV</b></p> <p><b>+/- 1.0 EV</b></p> <p>See <a href="#">Using exposure bracketing, page 28</a>.</p>





Setting	Icon	Options and icons that appear in Liveview
<p><b>Exposure Metering</b></p> <p>Evaluate light levels at specific areas of a scene.</p> <p><i>This setting remains until you change it. The setting is displayed on the right side of Liveview if set to Center-weight or Center-spot.</i></p>		<p><b>Multi-Pattern (default)</b> —evaluates lighting conditions throughout the image to give an optimum picture exposure. Ideal for general picture-taking.</p> <p><b>Center-Weight</b> —evaluates the lighting conditions of the subject centered in the viewfinder. Ideal for backlit subjects.</p> <p><b>Center-Spot</b> —similar to Center-weight, except the metering is concentrated on a smaller area of the subject centered in the viewfinder. (A circle indicates the metering spot.) Ideal when you need an exact exposure of a specific area in the picture.</p> <p>Unavailable in Auto, Scene, or Video modes.</p>
<p><b>Focus Zone</b></p> <p>Choose a large or concentrated area of focus.</p> <p><i>This setting remains until you change it. The setting is displayed on the right side of Liveview if set to Center-zone or Selectable-zone.</i></p>		<p><b>Multi-Zone (default)</b> —evaluates 3 zones to give an even picture focus. Ideal for general picture-taking.</p> <p><b>Center-Zone</b> —evaluates the small area centered in the viewfinder. Ideal when precise focus of a specific area in the picture is needed.</p> <p><b>Selectable-Zone</b> —move the focus brackets to center, left, or right.</p> <p>Unavailable in Auto, Scene, or Video modes.</p>









Setting	Icon	Options and icons that appear in Liveview
<p><b>AF Control</b></p> <p>Choose an auto-focus setting. <i>This setting remains until you change it.</i></p>		<p><b>Continuous AF (default)</b>—uses external AF sensor and TTL-AF (Through-The-Lens). Because the camera is always focusing, there is no need to press the Shutter button halfway down to focus.</p> <p><b>Single AF</b> —uses external AF sensor and TTL-AF when the Shutter button is pressed halfway down.</p> <p><b>Accessory Lens AF</b> —uses TTL-AF. Unavailable in Video mode.</p>
<p><b>Color Mode</b></p> <p>Choose color tones. <i>In Auto and Scene modes, this setting remains until you turn the Mode dial or turn off the camera.</i></p>		<p><b>High Color</b></p> <p><b>Natural Color (default)</b></p> <p><b>Low Color</b></p> <p><b>Black &amp; White</b></p> <p><b>Sepia</b> (for pictures with a reddish-brown, antique look.)</p> <p>NOTE: EasyShare software also lets you change a color picture to black-and-white or sepia, but you cannot change a black-and-white or sepia picture to color.</p> <p>Unavailable in Video mode.</p>
<p><b>Sharpness</b></p> <p>Control picture sharpness. <i>This setting remains until you change it.</i></p>		<p><b>High</b></p> <p><b>Normal (default)</b></p> <p><b>Low</b></p> <p>Unavailable in Auto, Scene, or Video modes.</p>
<p><b>Reset to Default</b></p> <p>Reset all picture-taking settings to the defaults.</p>		<p><b>Reset</b> P, A, S, M, or C mode to its default setting.</p>



Setting	Icon	Options and icons that appear in Liveview
<b>Set Album (Still)</b> Choose Album names. <i>This setting remains until you change it.</i>		<b>On or Off</b> Pre-select album names before you take pictures or videos. Then, all the pictures or videos you take are tagged with those album names. See <a href="#">page 39</a> .
<b>Image Storage</b> Choose a storage location for pictures and videos. <i>This setting remains until you change it.</i>		<b>Auto (default)</b>  —the camera uses the card if one is in the camera. If not, the camera uses internal memory. <b>Internal Memory</b>  —the camera always uses internal memory, even if a card is inserted.
<b>Video Length (Video)</b> Choose a default video length (useful in self-timer videos).		<b>Continuous (default)</b> —as long as there is room on the card or internal memory, or until you press the Shutter button. Choose <b>5, 15, or 30 seconds</b> duration.
<b>Setup Menu</b> Choose additional settings.		See <a href="#">Using setup to customize your camera</a> .

## Using setup to customize your camera

- 1 In any mode, press the Menu button.
- 2 Move the Joystick ▲/▼ to highlight Setup ☰, then press the OK button.
- 3 Move the Joystick ▲/▼ to highlight a setting, then press the OK button.
- 4 Choose an option, then press the OK button.
- 5 Press the Menu button to exit.

Setting	Icon	Options
<b>Return</b> to previous menu.		
<b>Quickview</b> Display a picture or video (for 5 seconds) after it is taken.		<b>On (default)</b> <b>Off</b>
<b>Advanced Digital Zoom</b> Choose how digital zoom is employed.		<b>Continuous</b> —no pause between optical and digital zoom. <b>Pause (default)</b> —after reaching 10X optical zoom, the zoom button must be released, then activated again to begin digital zoom. <b>None</b> —digital zoom is disabled.
<b>Print Warning</b>		<b>Pause (default)</b> —when the blue slider on the zoom indicator pauses during digital zoom, the zoom lever must be released and reactivated. The slider turns red when the picture may no longer render an acceptable 4 x 6 in. (10 x 15 cm) print. <b>None</b> —no pause.

Setting	Icon	Options
<b>Sound Themes</b>		<b>Shutter Only</b> <b>Default</b> <b>Classical</b> <b>Jazz</b> <b>Sci-fi</b>
<b>Sound Volume</b>		<b>Off</b> <b>Low (default)</b> <b>Medium</b> <b>High</b>
<b>Mode Description</b> Display mode description when entering a mode.		<b>On (default)</b> <b>Off</b>
<b>Date &amp; Time</b>		See <a href="#">page 6</a> .
<b>Video Out</b> Choose the regional setting that lets you connect the camera to a television or other external device.		<b>NTSC (default)</b> —used in North America and Japan. <b>PAL</b> —used in Europe and China.
<b>Orientation Sensor</b> Orient pictures so that they are displayed with the correct side up.		<b>On (default)</b> <b>Off</b>
<b>Date Stamp</b> Imprint the date on pictures.		Choose date format, or turn off the feature. (Default is off.)
<b>Video Date Display</b>		<b>On (default)</b> — choose from 3 date formats with or without hours and minutes. <b>Off</b>
<b>Language</b>		Choose a language (see <a href="#">page 5</a> ).

Setting	Icon	Options
<b>Format</b>  <b>CAUTION:</b> <b>Formatting deletes all pictures and videos, including those that are protected. Removing a card during formatting may damage the card.</b>		<b>Memory Card</b> —deletes everything on the card; formats the card. <b>Cancel</b> —exits without making a change. <b>Internal Memory</b> —deletes everything in internal memory including email addresses, album names, and favorites; formats the internal memory.
<b>About</b> View camera information.		Camera model/firmware information.

## Putting yourself in the picture or video

Use the Self-Timer to create a 2- or 10-second delay between the time you press the Shutter button and the time the picture or video is taken.

- 1 Place the camera on a flat surface or tripod.
- 2 Select the desired Still or Video mode.
- 3 Press the Menu button.
- 4 Move the Joystick ▲/▼ to highlight Self-Timer , then press the OK button.
- 5 Move the Joystick ▲/▼ to highlight 10 seconds (so you have time to get into the scene) or 2 seconds (for a steady, auto-shutter release on a tripod), then press the OK button.



- 6 Compose the scene. Then press the Shutter button **halfway and hold** to set the exposure and focus, then press **completely down**. Quickly position yourself in the scene.

*The Self-Timer light on the front of the camera blinks slowly for 8 seconds (then quickly for 2 seconds) before the picture/video is taken.*

*The Self-Timer turns off after you take the picture/video or if you change modes.*

NOTE: The default Video Length is Continuous. The video will stop when you press the Shutter button or when no storage space remains. To change the video length, see [page 35](#). To turn off the Self-Timer camera sounds, see [page 37](#).



## Pre-tagging for album names

Use the Set Album (Still or Video) feature to pre-select album names before you take pictures or videos. Then, all the pictures or videos you take are tagged with those album names.

### First—on your computer

Use Kodak EasyShare software that came with your camera (see [page 54](#)) to create album names on your computer. (To get the latest version of EasyShare software, go to [www.kodak.com/go/z7590downloads](http://www.kodak.com/go/z7590downloads).) Then copy up to 32 album names to the camera's album name list the next time you connect the camera to the computer. See Kodak EasyShare software Help for details.

### Second—on your camera

- 1 In any mode, press the Menu button.
- 2 Move the Joystick  to highlight Set Album , then press the OK button.
- 3 Move the Joystick  to highlight an album name, then press the OK button. Repeat to select more than one album name.  
*Selected albums are noted with a check mark.*

4 To remove a selection, highlight an album name and press the OK button. To remove all album selections, move the Joystick ▲/▼ to highlight Clear All.

5 Highlight Exit, then press the OK button.

*Your selections are saved. If you turn on the camera screen, your album selection is displayed on the screen. A plus (+) after the album name means more than one album is selected.*

6 Press the Menu button to exit the menu.

## Third—transfer to your computer

When you transfer the tagged pictures and videos to your computer (see [page 62](#)), the Kodak EasyShare software opens and categorizes your pictures and videos in the appropriate album. See the Kodak EasyShare software Help for details.

## Tips for better pictures

### Zoom

When you use longer zoom ranges, place the camera on a flat, steady surface or ideally use a tripod.

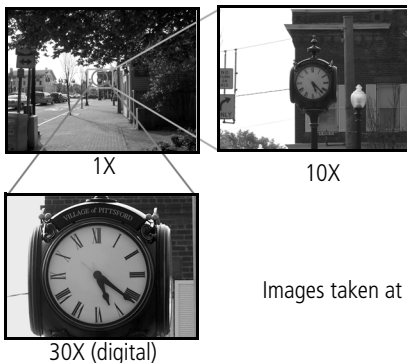

Images taken at f/3.7, 1/500 second

## Exposure compensation

When you want to control the exposure of backlit subjects or take images in varied light, use exposure compensation.

If the picture is too light, decrease (–) the setting; if it’s too dark, increase (+) the setting. Use the Jog dial to access this function (see [page 22](#)).

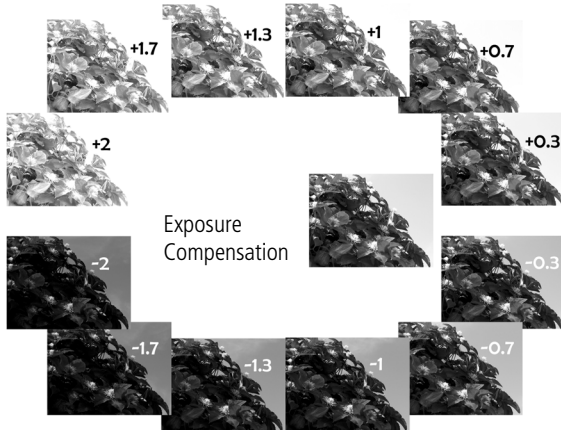

## Aperture and shutter speed (Manual mode)

You can manually choose the best combination of lens aperture (f-number) and shutter speed to obtain the appropriate exposure compensation for your particular setting.

Images have a greater focus range with a larger f-number, such as  $f/8$ . But it is not the best choice when shooting a moving object, so a smaller f-number is preferred, such as  $f/2.8$ .

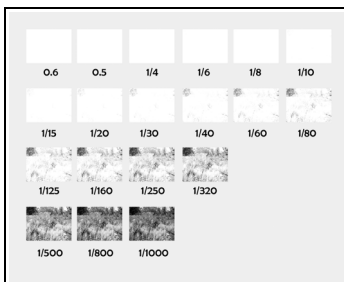

Wide Angle,  $f/2.8$

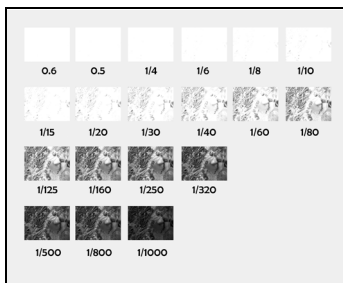

10X Zoom,  $f/3.6$



$f/8$

NOTE: Some of the shutter speeds are not shown.

## Fill flash

Fill flash is included on your camera (see [page 24](#)), and is a popular feature. Use fill flash for sunny-day portraits to fill in those dark shadows under the eyes, nose, or under the rim of a baseball hat. It's also useful for side- and back-lit scenes with nearby people or objects with detail you want to reveal.

Use Exposure Compensation, or Flash Compensation when needed, by adjusting the Jog dial (see [page 21](#)).

Fill-flash on



Fill-flash off

Images taken in Portrait mode

## Close ups with a close-up mode

The flower icon  on the camera indicates you have Close-up mode. Once in Close-up mode, your camera takes sharp pictures at close range (see [page 28](#)). The camera automatically sets the focus distance depending on the zoom position. Use available light instead of the flash, if possible.

Close-up telephoto lets you keep your distance from the subject (e.g., when you want to capture butterflies and bees on flowers without disturbing them).

Close-up wide  
at 5 in. (12.7 cm)



Close-up telephoto  
at 30 in. (76.2 cm)

Images taken at f/5, 1/500 second

# 3

## Reviewing pictures and videos

Press the Review button to view and work with your pictures and videos. To save battery power, use the optional Kodak EasyShare camera or printer dock, or Kodak 5-volt AC adapter. (See [www.kodak.com/go/z7590accessories](http://www.kodak.com/go/z7590accessories).)

### Viewing single pictures and videos

- 1 Press the Review button.
- 2 Move the Joystick ◀/▶ to scroll backward or forward through pictures and videos. (For fast scrolling, hold the Joystick ◀/▶.)
- 3 Press the Review button to exit Review.

NOTE: Pictures taken at the 4.4 MP (3:2) quality setting are displayed at a 3:2 aspect ratio with a black bar at the top of the screen.

## Checking camera status review mode

Press the Review button. The applied features of the current picture or video are displayed:

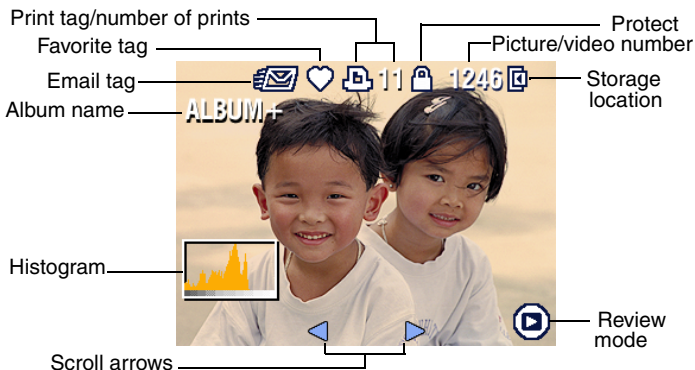



## Viewing multiple pictures and videos

- 1 Press the Review button.
- 2 Move the Joystick ▼.

NOTE: You can also press the Menu button, highlight Multi-up , then press the OK button.

*Thumbnails of pictures and videos are displayed.*

To display the previous or next row of thumbnails, move the Joystick ▲/▼.

To scroll through the thumbnails one at a time, move the Joystick ◀/▶.

To display a single view of the selected picture, press the OK button.

## Playing a video

- 1 Press the Review button.
- 2 Move the Joystick ◀/▶ to locate a video. (In Multi-up view, highlight a video, then press the OK button. When a video is highlighted in Multi-up view, the video duration is displayed at the top of the camera screen.)
- 3 To play or pause a video, press the OK button.

NOTE: You can also press the Menu button, highlight , then press the OK button.

To adjust the volume, move the Joystick ▲/▼.

To return to the beginning of the video, move the Joystick ◀ during playback.

To replay the video, press the OK button.

To go to the previous or next picture or video, move the Joystick ◀/▶.

## Deleting pictures and videos

- 1 Press the Review button.
- 2 Move the Joystick  $\blacktriangleleft/\blacktriangleright$  to locate a picture or video (or highlight one in Multi-up view), then press the Delete button.
- 3 Move the Joystick  $\blacktriangleup/\blacktriangledown$  to highlight an option, then press the OK button:
  - PICTURE or VIDEO**—deletes the displayed picture or video.
  - EXIT**—exits the Delete screen.
  - ALL**—deletes all pictures and videos from your current storage location.

To delete more pictures and videos, return to Step 2.

NOTE: You cannot delete protected pictures and videos this way. Remove protection before deleting (see [page 49](#)).



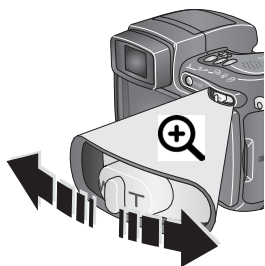





## Magnifying pictures





- 1 Press the Review button.
- 2 Push the Zoom button to magnify the picture between 1X and 8X.
  - To see different parts of the picture, move the Joystick  $\blacktriangleup/\blacktriangledown$   $\blacktriangleleft/\blacktriangleright$ .
  - To redisplay the picture at the 1X (original) size, press the OK button.
  - To exit Magnify, press the OK button.
  - To exit Review, press the Review button.

## Changing optional review settings

In Review, press the Menu button to access optional review settings.

	Album ( <a href="#">page 50</a> )		Copy ( <a href="#">page 53</a> )
	Protect ( <a href="#">page 49</a> )		Multi-Up ( <a href="#">page 47</a> )
	Image Storage ( <a href="#">page 35</a> )		Picture/Video Information ( <a href="#">page 50</a> )
	Slide Show ( <a href="#">page 51</a> )		Setup Menu ( <a href="#">page 36</a> )

## Protecting pictures and videos from deletion

- 1 Press the Review button.
- 2 Press the Menu button.
- 3 Move the Joystick  to highlight Protect , then press the OK button.  
*The picture or video is protected and cannot be deleted. The Protect icon  appears with the protected picture or video.*
- 4 To remove protection, press the OK button again.
- 5 Press the Menu button to exit the menu.



### CAUTION:

**Formatting internal memory or an SD or MMC card deletes all (including protected) pictures, videos. (Formatting internal memory also deletes email addresses, album names, and favorites. To restore them, see EasyShare software Help.)**

## Viewing picture/video information



- 1 Press the Review button.
- 2 Move the Joystick ◀/▶ to highlight a picture/video.
- 3 Press the Status ⓘ button once or twice to see information about the picture/video.

## Tagging pictures/videos for albums

Use the Album feature in Review to tag the pictures and videos in your camera with album names.

### First—on your computer

Use Kodak EasyShare software that came with your camera (see [page 54](#)) to create album names on your computer. (To get the latest version of EasyShare software, go to [www.kodak.com/go/z7590downloads](http://www.kodak.com/go/z7590downloads).) Then copy up to 32 album names to the camera's internal memory. See Kodak EasyShare software Help for details.

### Second—on your camera

- 1 Press the Review button.
- 2 Press the Menu button.
- 3 Move the Joystick ▲/▼ to highlight Album , then press the OK button.
- 4 Move the Joystick ▲/▼ to highlight an album, then press the OK button.

To add other pictures to the same album, move the Joystick ◀/▶ to scroll through pictures. When you see the picture you want, press the OK button.

To add the pictures to more than one album, repeat step 4 for each album.

*The album name appears with the picture. A plus (+) after the album name means the picture was added to more than one album.*

To remove a selection, highlight an album name and press the OK button. To remove all album selections, select Clear All.



### Third—transfer to your computer

When you transfer the tagged pictures and videos to your computer (see [page 62](#)), the Kodak EasyShare software opens and categorizes your pictures and videos in the appropriate album. See Kodak EasyShare software Help for details.

## Running a slide show

Use the Slide Show to display your pictures and videos on the camera screen. To run a slide show on a television or on any external device, see [page 52](#). To save battery power, use an optional Kodak 5V AC adapter. (Visit [www.kodak.com/goz7590accessories](http://www.kodak.com/goz7590accessories).)

### Starting the slide show

- 1 Press the Review button, then press the Menu button.
- 2 Move the Joystick  to highlight Slide Show , then press the OK button.
- 3 Move the Joystick  to highlight Begin Show, then press the OK button.  
*Each picture and video is displayed once, in the order in which you took them.*

To interrupt the Slide Show, press the OK button.

### Changing the slide show display interval

The default interval setting displays each picture for 5 seconds. You can change the display interval from 3 seconds to 60 seconds.

- 1 On the Slide Show menu, move the Joystick  to highlight Interval, then press the OK button.

**2** Select a display interval.

To scroll through the seconds quickly, hold the Joystick ▲/▼.

**3** Press the OK button.

*The interval setting remains until you change it.*

## Running a continuous slide show loop

When you turn on Loop, the slide show is continuously repeated.

**1** On the Slide Show menu, move the Joystick ▲/▼ to highlight Loop, then press the OK button.

**2** Move the Joystick ▲/▼ to highlight On, then press the OK button.

*The slide show repeats until you press the OK button or until battery power is exhausted.*

## Displaying pictures and videos on a television

You can display pictures and videos on a television, computer monitor, or any device equipped with a video input. (Image quality on a television screen may not be as good as on a computer monitor or when printed.)

NOTE: Ensure that the Video Out setting (NTSC or PAL) is correct (see [page 37](#)). The slide show stops if you connect or disconnect the cable while the slide show is running.

**1** Connect the audio/video cable (included) from the camera video-out port to the television video-in port (yellow) and audio-in port (white). See your television user's guide for details.

**2** Review pictures and videos on the television.

## Copying pictures and videos

You can copy pictures and videos from a card to internal memory or from internal memory to a card.

### Before you copy, make sure that:

- A card is inserted in the camera.
- The camera's picture storage location is set to the location **from** which you are copying. See [page 35](#).

### Copy pictures or videos:

- 1 Press the Review button, then press the Menu button.
- 2 Move the Joystick ▲/▼ to highlight Copy ►►, then press the OK button.
- 3 Move the Joystick ▲/▼ to highlight an option:

**PICTURE or VIDEO**—copies the current picture or video.

**EXIT**—returns to the Review menu.

**ALL**—copies all pictures and videos from your selected storage location to the other location.

- 4 Press the OK button.

NOTE: Pictures and videos are copied, not moved. To remove pictures and videos from the original location after they are copied, delete them (see [page 48](#)).

Tags that you applied for print, email, and favorites are not copied. Protection settings are not copied. To apply protection to a picture or video, see [page 49](#).

# 4

## Installing the software

### Minimum system requirements

- Windows 98, 98SE, ME, 2000 SPI, or XP OS  
Internet Explorer 5.01 or higher  
233 MHz processor or greater
- Macintosh OS X 10.2.3, 10.3  
Safari 1.0 or higher

### Minimum hardware requirements

- 128 MB RAM (64 MB RAM for Windows 98, 98SE, 2000 SPI, or ME OS)
- 200 MB hard disk space available
- CD-ROM drive
- Available USB port



## Install the software



### CAUTION:

**Install Kodak EasyShare software *before* connecting the camera or optional dock to the computer. Failure to do so may cause the software to install incorrectly.**

- 1 Close all software applications that are open on your computer (including anti-virus software).
- 2 Place the Kodak EasyShare software CD into the CD-ROM drive.
- 3 Install the software:

**Windows OS-based computer**—if the install window does not appear, choose Run from the Start menu and type **d:\setup.exe** where **d** is the drive letter that contains the CD.

**Mac OS X**—double-click the CD icon on the desktop, then click the Install icon.

- 4 Follow the on-screen instructions to install the software.

**Windows OS-based computer**—select Complete to automatically install all the applications. Select Custom to choose the applications you wish to install.

**Mac OS X**—follow the on-screen instructions.

NOTE: When prompted, take a few minutes to electronically register your camera and software. This lets you receive information regarding software updates and registers some of the products included with the camera. You must be connected to your Internet service provider to register electronically. To register later, see [www.kodak.com/go/register](http://www.kodak.com/go/register).

- 5 Restart the computer. If you turned off anti-virus software, turn it back on. See the anti-virus software manual for details.

For information on the software applications included on the Kodak EasyShare software CD, click the Help button in the Kodak EasyShare software.



## 5

# Sharing pictures and videos



Press the Share button to “tag” your pictures and videos.

When they are transferred to your computer, you can share them by:

	Pictures	Videos
 Print ( <a href="#">page 57</a> )	✓	
 Email ( <a href="#">page 58</a> )	✓	✓
 Favorites ( <a href="#">page 59</a> ) for easy organization on your computer and for sharing on your camera	✓	✓







NOTE: Share tags remain until removed. If a tagged picture/video is copied on the camera, the Share tag is **not** copied. (If a tagged picture/video is copied in EasyShare software, the Share tag is copied.) In a burst series, only the last picture is tagged during Quickview.

## When can I tag my pictures and videos?





**Press the Share button to tag pictures/videos:**

- Any time (The most recent picture/video taken is displayed.)
- Just after you take a picture/video, during Quickview (see [page 15](#)).
- After pressing the Review button (see [page 45](#)).

## Tagging pictures for printing

- 1 Press the Share button. Move the Joystick   to locate a picture.
- 2 Move the Joystick   to highlight Print , then press the OK button.\*
- 3 Move the Joystick   to select the number of copies (0-99). Zero removes the tag for that picture.

*The Print icon  appears in the status area. The default quantity is one.*

- 4 **Optional:** You can apply a print quantity to other pictures. Move the Joystick   to locate a picture. Keep the print quantity as is, or press   to change it. Repeat this step until the desired print quantity is applied to the pictures.
  - 5 Press the OK button. Then press the Share button to exit the menu.
- \* To tag all pictures in the storage location, highlight Print All, press the OK button, then indicate the number of copies as described above. Print All is not available in Quickview.

To remove the print tagging for all pictures in the storage location:

- Highlight Cancel Prints, then press the OK button.
- Select either Yes or No to delete all prints.
- Press the OK button.

Cancel Prints is not available in Quickview.

## Printing tagged pictures

When you transfer the tagged pictures to your computer, the Kodak EasyShare software print screen opens. For details on printing, click the Help button in the Kodak EasyShare software. For more information on printing from your computer, printer dock, or card, see [page 65](#).









NOTE: For the best 4 x 6 in. (10 x 15 cm) prints, set the camera to the 4.4 MP (3:2) print quality setting (see [page 31](#)).



## Tagging pictures and videos for emailing

### First—on your computer

Use Kodak EasyShare software that came with your camera to create an email address book on your computer. (To get the latest version of EasyShare software, go to [www.kodak.com/go/z7590downloads](http://www.kodak.com/go/z7590downloads).) Then copy up to 32 email addresses to the camera's internal memory. See the Kodak EasyShare software Help for details.



### Second—tag pictures/videos on your camera

- 1 Press the Share button. Move the Joystick   to locate a picture/video.
- 2 Move the Joystick   to highlight Email , then press the OK button.  
*The Email icon  appears in the status area.*
- 3 Move the Joystick   to highlight an email address, then press the OK button.

To tag other pictures/videos with the same address, move the Joystick   to scroll through them. When the picture you want is displayed, press OK.

To send the pictures/videos to more than one address, repeat step 3 for each address.

*Selected addresses are checked.*

- 4 To remove a selection, highlight a checked address and press the OK button. To remove all email selections, highlight Clear All.
- 5 Move the Joystick   to highlight Exit, then press the OK button.  
*The Email icon  appears in the status area.*
- 6 Press the Share button to exit the menu.

## Third—transfer and email





When you transfer the tagged pictures and videos to your computer (see [page 62](#)), the email screen opens and lets you send them to the addresses you specified. See the Kodak EasyShare software Help for details.



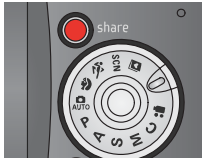

## Tagging pictures as favorites

You can store your favorite pictures in the Favorites  section of your camera's internal memory, then share them with friends and family.

NOTE: When you transfer pictures from your camera to your computer, all pictures (including favorites) are stored on your computer at full size. Favorite pictures—smaller copies of your originals—are loaded back to your camera, so you can share and enjoy more.

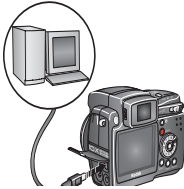
### Share your favorite pictures in 4 easy steps:





<p><b>1. Take pictures</b></p> 	
<p><b>2. Tag pictures as favorites</b></p> 	<ol style="list-style-type: none"> <li>1 Press the Share button. Move the Joystick  to locate a picture.</li> <li>2 Move the Joystick  to highlight Favorite , then press the OK button.           <p><i>The Favorite icon  appears in the status area. To remove the tag, press the OK button again. Press the Share button to exit the menu.</i></p> </li> </ol>

<p><b>3. Transfer pictures to your computer</b></p> 	<p><b>1</b> To enjoy full functionality, load and use Kodak EasyShare software that came with your camera (see <a href="#">page 54</a>).</p> <p><b>2</b> Connect the camera to the computer using the USB cable (see <a href="#">page 62</a>) or an EasyShare dock.</p> <p><i>The first time you transfer pictures, a software wizard helps you make choices about your favorite pictures. Then, your pictures are transferred to the computer. Favorite pictures are loaded to the Favorites section of your camera's internal memory.</i></p>
<p><b>4. View favorites on your camera</b></p> 	<p><b>1</b> Turn the Mode dial to Favorites .</p> <p><b>2</b> Move the Joystick  to scroll through favorites.</p> <p>To exit Favorites mode, turn the Mode dial to any other position.</p> <p>To view pictures/videos on a card or in non-favorite internal memory, press the Review button. (See <a href="#">page 45</a>.)</p>

NOTE: The camera holds a limited number of favorites. Use Camera Favorites in the EasyShare software to customize the size of your camera Favorites section. For more information, click the Help button in the Kodak EasyShare software.



## Optional settings

In Favorites mode, press the Menu button to access optional settings.

	Slide Show ( <a href="#">page 51</a> )		Remove all favorites ( <a href="#">page 61</a> )
	Multi-up ( <a href="#">page 47</a> )		Setup Menu ( <a href="#">page 36</a> )

NOTE: Pictures taken at the 4.4 MP (3:2) quality setting are displayed at a 3:2 aspect ratio with a black bar at the top of the screen. (See [Picture Size, page 31](#).)

## Removing all favorites from your camera

- 1 Turn the Mode dial to Favorites .
- 2 Press the Menu button.
- 3 Highlight , then press the OK button.

*All pictures stored in the Favorites section of internal memory are removed. Favorites are restored to your camera the next time you transfer pictures to the computer. To remove single favorites, do so in EasyShare software.*





- 4 Press the Menu button to exit the menu.

## Preventing favorites from transferring to the camera

- 1 Open the Kodak EasyShare software. Click the My Collection tab.
- 2 Go to the Albums view.
- 3 Click the Camera Favorites Album for your camera.
- 4 Click Remove Album.

*The next time you transfer pictures from your camera to the computer, use the Camera Favorites Wizard/Assistant in EasyShare software to recreate your Camera Favorites Album or to turn off the Camera Favorites feature.*

## Printing and emailing favorites

- 1 Turn the Mode dial to Favorites . Press / to locate a picture.
- 2 Press the Share button.
- 3 Highlight Print  or Email , then press the OK button.

NOTE: Favorites that were taken on this camera (not imported from another source) are good for a 4 x 6 in. (10 x 15 cm) print.

# 6

## Transferring and printing pictures



### CAUTION:

Install Kodak EasyShare software *before* connecting the camera or optional dock to the computer. Failure to do so may cause the software to install incorrectly.

### Transferring pictures/videos with the USB cable

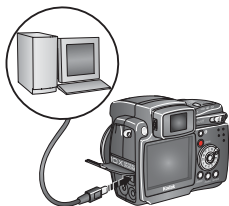

- 1 Turn off the camera.
- 2 Plug the labeled  end of the USB cable into the labeled USB port on your computer. See your computer user's guide for details.
- 3 Plug the other end of the USB cable into the labeled USB port on the camera.
- 4 Turn on the camera.

*Kodak EasyShare software opens on your computer. The software prompts you through the transfer process.*

NOTE: Visit [www.kodak.com/go/howto](http://www.kodak.com/go/howto) for an online tutorial on connecting.

### Also available for transferring

You can also use these Kodak products to transfer your pictures and videos:

- Kodak EasyShare camera dock, Kodak EasyShare printer dock
- Kodak multi-card reader, Kodak SD multimedia card reader-writer

Purchase these and other accessories at a dealer of Kodak products or [www.kodak.com/go/z7590accessories](http://www.kodak.com/go/z7590accessories).



## Printing from a Kodak EasyShare printer dock or your computer

**Computer**—Click the Help button in the Kodak EasyShare software for details on printing from your computer.

**Printer dock**—Dock your camera to the Kodak EasyShare printer dock and print directly with or without a computer. Purchase this and other accessories at a dealer of Kodak products or [www.kodak.com/go/z7590accessories](http://www.kodak.com/go/z7590accessories).

## Printing from an optional SD or MMC card

- Automatically print tagged pictures when you insert your card into a printer with an SD or MMC card slot. See your printer user's guide for details.
- Make prints at an SD or MMC card-capable Kodak picture maker. (Contact a location prior to visiting. See [www.kodak.com/go/picturemaker](http://www.kodak.com/go/picturemaker).)
- Take the card to your local photo retailer for professional printing.

## Ordering prints online

Kodak EasyShare print service (provided by Ofoto, [www.ofoto.com](http://www.ofoto.com)) is one of the many online print services offered in the Kodak EasyShare software. You can easily:

- Upload your pictures.
- Edit, enhance, and add borders to your pictures.
- Store pictures, and share them with family and friends.
- Order high-quality prints, photo greeting cards, frames, and albums—and have them delivered to your door.

## **Direct printing with a PictBridge-enabled printer**

Your camera features PictBridge technology, which lets you print directly to PictBridge-enabled printers, without a computer. You need:

- Camera with fully charged batteries, or with optional Kodak 5-volt AC adapter
- PictBridge-enabled printer
- USB cable included with your camera

### **Connecting the camera to the printer**

- 1** Turn off the camera and printer.
- 2** Optional: If you have a Kodak 5-volt AC adapter (optional accessory), plug it into the camera and into an electrical outlet.
- 3** Using the USB cable that came with your camera, connect the camera to the printer. (See your printer user's guide for details.)

## Printing pictures

- 1 Turn on the printer. Turn the camera Mode dial to Auto.

*The PictBridge logo is displayed, followed by the current picture and menu. (If no pictures are found, a message is displayed.) If the menu interface turns off, press any button to redisplay it.*

- 2 Move the Joystick  to choose a printing option, then press the OK button.

<b>Current Picture</b>	Press  to choose a picture. Choose the number of copies.
<b>Tagged Pictures</b>	If your printer is capable, print pictures that you tagged for printing (see <a href="#">page 57</a> ) and choose a print size.
<b>Index Print</b>	Print thumbnails of all pictures. This requires one or more sheets of paper. If the printer is capable, choose a print size.
<b>All Pictures</b>	Print all pictures in internal memory, on a card, or in Favorites. Choose the number of copies.
<b>Image Storage</b>	Access internal memory, a card, or Favorites.

NOTE: During direct printing, pictures are not permanently transferred or saved to the computer or printer. To transfer pictures to your computer, see [page 62](#). If you turned the Mode dial to Favorites, the current favorite picture is displayed.

## Disconnecting the camera from the printer

- 1 Turn off the camera and printer.
- 2 Disconnect the USB cable from the camera and the printer.

## Dock compatibility for your camera

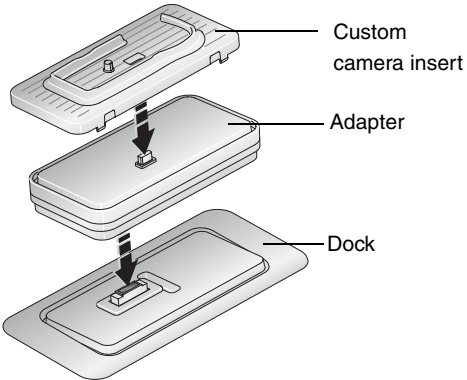
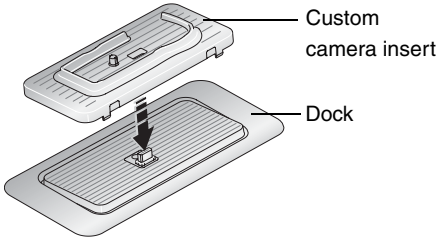
Kodak EasyShare dock	Docking configuration
<ul style="list-style-type: none"> <li>■ printer dock 4000</li> <li>■ camera dock II</li> <li>■ LS420, LS 443 camera dock</li> </ul>	<p>Not compatible</p>
<ul style="list-style-type: none"> <li>■ printer dock</li> <li>■ printer dock plus</li> <li>■ printer dock 6000</li> <li>■ camera dock 6000</li> </ul>	 <p>The diagram illustrates the assembly process for compatible docks. It shows three components: a custom camera insert, an adapter, and a dock. The custom camera insert is shown being inserted into the adapter. The adapter is then shown being inserted into the dock. Labels with leader lines identify each component: Custom camera insert, Adapter, and Dock.</p>
<ul style="list-style-type: none"> <li>■ others, including series 3 printer docks and camera docks</li> </ul>	 <p>The diagram illustrates the assembly process for other docks. It shows two components: a custom camera insert and a dock. The custom camera insert is shown being inserted directly into the dock. Labels with leader lines identify each component: Custom camera insert and Dock.</p>

Purchase camera docks, printer docks, and other accessories at a dealer of Kodak products or [www.kodak.com/go/z7590accessories](http://www.kodak.com/go/z7590accessories).

## 7

# Troubleshooting

When you have questions about your camera, start here. Additional technical information is available in the ReadMe file located on the Kodak EasyShare software CD. For updates to Troubleshooting information, see [www.kodak.com/go/z7590support](http://www.kodak.com/go/z7590support).

## Camera problems

If...	Try one or more of the following
Camera does not turn on	<ul style="list-style-type: none"> <li>■ Remove battery and verify that it's the correct type, then reinsert it.</li> </ul>
Camera does not turn off and the lens does not retract	<ul style="list-style-type: none"> <li>■ Insert a charged battery.</li> <li>■ Place the camera on a Kodak EasyShare camera or printer dock (sold separately), then try again.</li> </ul>
Camera buttons and controls do not function	<ul style="list-style-type: none"> <li>■ Connect the camera to a Kodak 5-volt AC adapter (sold separately), then try again. See <a href="#">page 2</a> for more battery information.</li> </ul>
Lens does not extend when camera turns on or does not retract	<ul style="list-style-type: none"> <li>■ Confirm that the battery in camera is charged.</li> <li>■ Turn camera on and off again.</li> <li>■ If problem still exists, get help (see <a href="#">page 74</a>).</li> </ul>
EVF/LCD screen is black or does not turn on	<ul style="list-style-type: none"> <li>■ Remove the lens cap.</li> <li>■ Push the EVF/LCD toggle button to change display.</li> </ul>
In Review, a blue or black screen is displayed instead of a picture	<ul style="list-style-type: none"> <li>■ Transfer the picture to the computer.</li> <li>■ Transfer <i>all</i> pictures to the computer (see <a href="#">page 62</a>).</li> <li>■ Take another picture. If problem still continues try internal memory and/or another memory card.</li> </ul>

If...	Try one or more of the following
Pictures remaining number does not decrease after taking a picture	<ul style="list-style-type: none"> <li>■ Continue taking pictures. The camera is operating normally. (The camera estimates the number of pictures remaining after each picture is taken, based on picture size and content.)</li> </ul>
Picture orientation is not accurate	<ul style="list-style-type: none"> <li>■ Set the Orientation Sensor to ON (page 37).</li> </ul>
Flash does not fire	<ul style="list-style-type: none"> <li>■ Open the flash unit (page 23).</li> <li>■ Check the flash setting and change as needed (page 23).</li> </ul>
Storage location is almost or entirely full	<ul style="list-style-type: none"> <li>■ Transfer pictures to the computer (page 62).</li> <li>■ Delete pictures from the card or insert a new one (page 8).</li> <li>■ Change image storage location to internal memory (page 35).</li> </ul>
Battery life is short	<ul style="list-style-type: none"> <li>■ Wipe the contacts with a clean, dry cloth (page 83) before inserting a battery in the camera.</li> <li>■ Insert a charged battery (page 1).</li> </ul>
You cannot take a picture	<ul style="list-style-type: none"> <li>■ Turn the camera off, then on again.</li> <li>■ Depress shutter button all the way (page 9).</li> <li>■ Insert a charged battery (page 1).</li> <li>■ Wait until the AF/AE indicator turns green before attempting to take another picture.</li> <li>■ Memory full. Transfer pictures to the computer (page 62), delete pictures from the camera (page 48) or card, change image storage location, or insert a new card.</li> </ul>

If...	Try one or more of the following
Error message appears on EVF/LCD screen	<ul style="list-style-type: none"> <li>■ Turn the camera off.</li> <li>■ Remove memory card from the camera.</li> <li>■ Remove the battery and wipe the contacts with a clean, dry cloth (<a href="#">page 83</a>).</li> <li>■ Reinstall the battery.</li> <li>■ Turn on the camera.</li> <li>■ If all else fails, get customer support help (see <a href="#">page 75</a>).</li> </ul>
Memory card not recognized or camera freezes with card.	<ul style="list-style-type: none"> <li>■ Card may be corrupted. Format card in camera (see <a href="#">page 8</a>).</li> <li>■ Use another memory card.</li> </ul>

## Computer/connectivity problems

If...	Try one or more of the following
Computer does not communicate with the camera	<ul style="list-style-type: none"> <li>■ Turn on the camera.</li> <li>■ Insert a charged battery (page 1).</li> <li>■ Make sure USB cable is securely connected on camera and computer port (page 62).</li> <li>■ Make sure the EasyShare software is installed (page 54).</li> </ul>
Pictures do not transfer to computer	<ul style="list-style-type: none"> <li>■ Click the Help button in the EasyShare software.</li> </ul>
Slide Show does not run on an external video device	<ul style="list-style-type: none"> <li>■ Adjust the camera Video Out setting (NTSC or PAL, page 37).</li> <li>■ Make sure the external device settings are correct (see the device's user's guide).</li> </ul>

## Picture quality problems

If...	Try one or more of the following
Picture is too dark or underexposed	<ul style="list-style-type: none"> <li>■ Reposition camera for more available light.</li> <li>■ Use Fill flash (page 23) or change your position so light is not behind the subject.</li> <li>■ Move so that the distance between you and the subject is within the effective flash range (page 23).</li> <li>■ To automatically set exposure and focus, press the Shutter button <b>halfway and hold</b>. When the AF/AE indicator turns green, press the Shutter button <b>completely down</b> to take the picture.</li> <li>■ Use P mode to adjust the Exposure and Flash Compensations (page 22).</li> <li>■ Use P mode (page 22) and Selectable Zone (see Focus Zone on page 33).</li> </ul>



If...	Try one or more of the following
Picture is too light	<ul style="list-style-type: none"> <li>■ Reposition camera to reduce the amount of available light.</li> <li>■ Turn flash off (<a href="#">page 23</a>).</li> <li>■ Move so that the distance between you and the subject is within the effective flash range (<a href="#">page 23</a>).</li> <li>■ To automatically set exposure and focus, press the Shutter button <b>halfway and hold</b>. When the AF/AE indicator turns green, press the Shutter button <b>completely down</b> to take the picture.</li> <li>■ Use P mode to adjust the Exposure and Flash Compensations (<a href="#">page 22</a>).</li> </ul>
Picture is not clear	<ul style="list-style-type: none"> <li>■ To automatically set exposure and focus, press the Shutter button <b>halfway and hold</b>. When the AF/AE indicator turns green, press the Shutter button <b>completely down</b> to take the picture.</li> <li>■ Clean the lens (<a href="#">page 83</a>).</li> <li>■ Make sure camera is not in Close-up mode if you are more than 21 in. (0.7 m) from your subject.</li> <li>■ Place the camera on a flat, steady surface or use a tripod, especially in high-zoom settings or in low light.</li> </ul>

## Power-ring-light status

Status	Cause
Power ring does not turn on and the camera does not work.	<ul style="list-style-type: none"> <li>■ Turn on the camera.</li> <li>■ Recharge the battery or install a new one (<a href="#">page 2</a>).</li> <li>■ Turn Mode dial off, then back on.</li> </ul>
Power ring glows steady green.	<ul style="list-style-type: none"> <li>■ Camera is on and ready to take a picture or video.</li> </ul>
Power ring glows steady amber.	<ul style="list-style-type: none"> <li>■ Camera is in Favorite mode.</li> <li>■ Camera firmware update is in process.</li> <li>■ Camera is connected to computer, USB connection is active.</li> <li>■ Date and time set with lens retracted.</li> </ul>
Power ring blinks green.	<ul style="list-style-type: none"> <li>■ Camera turned off while picture is being processed and saved. Camera operating normally. Processing is completed before power off.</li> <li>■ Do not remove the card while the light is blinking.</li> <li>■ Camera operating normally at power up. Take pictures when the blinking stops.</li> <li>■ Camera operating normally during connect mode to computer.</li> </ul>
Power ring blinks amber.	<ul style="list-style-type: none"> <li>■ Battery is low or exhausted. Recharge the battery (<a href="#">page 1</a>).</li> <li>■ Internal camera temperature is too high. Turn the camera off for several minutes; then turn it back on. If the condition continues, get help (<a href="#">page 75</a>).</li> </ul>

## Direct printing (PictBridge) problems

Status	Cause	Solution
Cannot locate desired picture.	The Mode dial is set to Favorites.	Turn the Mode dial to Auto.
	Camera is accessing a card or internal memory.	Use the Direct print menu to change the image storage location.
The Direct print menu interface turns off.	The menu interface has timed out.	Press any button to redisplay it.
Cannot print pictures.	There is a connection issue.	Ensure that there is a connection between camera and printer ( <a href="#">page 64</a> ).
	There is a power issue.	Ensure the printer and camera have power ( <a href="#">page 64</a> ).
Camera or printer displays an error message.	There is a camera or printer issue.	Follow the prompts to resolve the issue.

### Still having problems?

Visit [www.kodak.com/go/z7590support](http://www.kodak.com/go/z7590support), or see [Chapter 8, Getting help](#).

For Direct printing issues, contact the printer manufacturer.

## 8

## Getting help

## Helpful links

<b>Camera</b>	Get support for your product (FAQs, troubleshooting information, etc.)	<a href="http://www.kodak.com/go/z7590support">www.kodak.com/go/z7590support</a>
	Purchase camera accessories (camera docks, printer docks, lenses, cards, etc.)	<a href="http://www.kodak.com/go/z7590accessories">www.kodak.com/go/z7590accessories</a>
	Download the latest camera firmware and software	<a href="http://www.kodak.com/go/z7590downloads">www.kodak.com/go/z7590downloads</a>
	See online demonstrations of your camera	<a href="http://www.kodak.com/go/howto">www.kodak.com/go/howto</a>
<b>Software</b>	Get information on EasyShare software	<a href="http://www.kodak.com/go/easysharesw">www.kodak.com/go/easysharesw</a> (or click the Help button in the EasyShare software)
	Get help with the Windows operating system and working with digital pictures	<a href="http://www.kodak.com/go/pcbasics">www.kodak.com/go/pcbasics</a>
<b>Other</b>	Get support for other cameras, software, accessories, more	<a href="http://www.kodak.com/go/support">www.kodak.com/go/support</a>
	Get information on Kodak EasyShare printer docks	<a href="http://www.kodak.com/go/printerdocks">www.kodak.com/go/printerdocks</a>
	Get information on Kodak inkjet products	<a href="http://www.kodak.com/go/inkjet">www.kodak.com/go/inkjet</a>
	Optimize your printer for truer, more vibrant colors	<a href="http://www.kodak.com/go/onetouch">www.kodak.com/go/onetouch</a>
	Register your camera	<a href="http://www.kodak.com/go/register">www.kodak.com/go/register</a>

## Telephone customer support

If you have questions concerning the operation of the software or camera, you may speak with a customer support representative. Before you call, have the camera or dock connected to your computer. Be at your computer, and have the following information available:

- Computer model, Operating system
- Processor type and speed (MHz)
- Amount of memory (MB) & free hard disk space
- Camera serial number
- Version of Kodak EasyShare software
- Exact error message you received

Australia	1800 147 701	Greece	00800 441 25605	Spain	91 749 76 53
Austria	0179 567 357	Hong Kong	800 901 514	Sweden	08 587 704 21
Belgium	02 713 14 45	India	91 22 617 5823	Switzerland	01 838 53 51
Brazil	0800 150000	Italy	02 696 33452	Taiwan	0800 096 868
Canada	1 800 465 6325	Japan	03 5540 9002	Thailand	001 800 631 0017
China	800 820 6027	Korea	00798 631 0024	UK	0870 243 0270
Denmark	3 848 71 30	Netherlands	020 346 9372	US	1 800 235 6325
Indonesia	001 803 631 0010	New Zealand	0800 440 786	Outside US	585 726 7260
Ireland	01 407 3054	Norway	23 16 21 33	International Toll Line	+44 131 458 6714
Finland	0800 1 17056	Philippines / Metro Manila	1 800 1 888 9600 / 632 6369600	International Toll Fax	+44 131 458 6962
France	01 55 1740 77	Portugal	021 415 4125		
Germany	069 5007 0035	Singapore	800 6363 036		

Visit: <http://www.kodak.com/US/en/digital/contacts/DAInternationalContacts.shtml>

## Camera specifications

For more specifications, visit [www.kodak.com/go/z7590support](http://www.kodak.com/go/z7590support).

<b>Kodak EasyShare Z7590 zoom digital camera</b>	
<b>CCD</b> (charge-coupled device)	
CCD	1/2.5 in. CCD, 4:3 aspect ratio
Output image size (picture size)	2576 x 1932 (5.0 M) pixels 2576 x 1716 (4.4 M) pixels 2304 x 1728 (4.0 M) pixels 2048 x 1536 (3.1 M) pixels 1552 x 1164 (1.8 M) pixels
<b>Display</b>	
Color LCD	Hybrid high-resolution display 2.2 in. (55.9 mm); 640 x 240 (153K) pixels
Color Viewfinder— Electronic (EVF)	LCD and EVF not simultaneous; 0.26 in. (6.5 mm), (311k) pixels.
Preview (LCD/EVF)	Frame rate: 30 fps
<b>Lens</b>	
Taking lens	10X optical zoom lens, f/2.8–f/3.7, 38–380 mm (35 mm equivalent)

<b>Kodak EasyShare Z7590 zoom digital camera</b>	
Focus system	Hybrid AF External Passive Sensor; Multi-, Center-, or Selectable-Zones. Continuous AF in movie and preview modes. Working range: Standard wide: 2.0 ft (0.6 m) to infinity Standard tele: 6.6 ft (2.0 m) to infinity Close-up wide: 4.7 to 27.6 in. (0.12 to 0.7 m) Close-up tele: 3.9 to 6.9 ft (1.2 to 2.1 m) Wide and tele infinity: 65.6 ft (20 m) to infinity
Digital zoom	3.0X continuous advanced zoom, 0.2X increments that starts at 10X optical zoom (LCD display mode)
Optical zoom	10X, 38–380 mm (35 mm equivalent); F= 6.32–63.2 mm actual
Accessory lens thread	Yes (inside lens ring)
Lens barrier	Lens cap
<b>Exposure</b>	
Exposure metering	TTL–AE with program modes; Multi-Pattern AE, Center-Weight AE, Center-Spot AE
Exposure range	AE range: EV 5.3 to 16.0 (@ wide) Full range: EV 0 to 16.0 (@ wide)
Exposure mode	Programmed AE mode: Auto, P, A, S, M, and C, Scene modes. Aperture Priority AE: f/2.8–f/8 @ wide Shutter Priority AE: 16–1/1000 sec. @ wide Full Manual Exposure (Noise Reduction: subtraction of black image @ >0.7 sec.) Exposure Compensation: +2.0 EV with 1/3 EV step
Shutter speed	Mechanical shutter with CCD electrical. Auto 16–1/1700 sec., Manual 16–1/1000 sec.

<b>Kodak EasyShare Z7590 zoom digital camera</b>	
ISO speed	Auto: 80, 100, 200, 400, and 800 (800 @ 1.8 MP) Selectable: P, A, S, M, and C Mode
<b>Flash</b>	
Electronic flash	Guide no. 12 @ ISO 140; auto flash with photo sensor Working range: Wide: 2–16.1 ft (0.6–4.9 m) @ ISO 140 Tele: 6.6–12.1 ft (2.0–3.7 m) @ ISO 140
Flash modes	Auto, Fill, Red-eye, Off
External flash sync	Yes, 500-volts maximum
<b>Capture</b>	
Capture modes	Auto, Program, Aperture Priority, Shutter Priority, Manual, Custom, Sport, Portrait, Scenes (14), Burst, Video
Jog dial	Used to adjust Exposure Compensation, Aperture Priority AE, Shutter Priority AE, ISO, Flash Compensation, Full Manual Exposure.
Burst mode	First Burst 5 pictures; Last Burst 4 pictures; both @ 2.0 fps (AE, AF, AWB executed for first shot only.)
Still image buffer	32 MB internal memory
Video capture	Image size/frame rate: VGA (640 x 480) at 12 fps, QVGA (320 x 240) at 20 fps
Image file format	Still: EXIF 2.21 (JPEG compression), file organization DCF Video: QuickTime (CODEC MPEG4)
Image storage	Optional MMC or SD Card  (The SD logo is a trademark of the SD Card Association.)
Internal storage capacity	32 MB internal memory
<b>Review</b>	
Quickview	Yes



<b>Kodak EasyShare Z7590 zoom digital camera</b>	
Video output	NTSC or PAL
<b>Power</b>	
Kodak EasyShare Li-Ion rechargeable battery (KLIC-5000); 5V AC adapter, optional	
<b>Communication with computer</b>	
USB, via USB cable; EasyShare camera dock or printer dock	
<b>Languages</b>	
English/German/Spanish/French/Italian/Portuguese/Chinese/Korean/Japanese	
<b>Other features</b>	
Self-timer	10 seconds
Sound feedback	Power up, shutter, self-timer, error, sound modes
White balance	Auto, Daylight, Tungsten, Fluorescent, Open Shade
Auto sleep mode	Yes. 8 minutes
Color modes	High Color, Natural Color, Low Color, Black & White, Sepia
Sharpness	High, Normal, Low
Date stamp	None, YYYY/MM/DD, MM/DD/YYYY, DD/MM/YYYY
Tripod mount	1/4 inch metal
Size	3.9 in. (99.6 mm) x 3.2 in. (81.2 mm) x 3.2 in. (79.9 mm)
Weight	12 oz (340 g) without battery and card

## Storage capacities

File sizes can vary due to image content and exposure. You may be able to store more or fewer pictures and videos. Favorites take up additional space in internal memory and reduce storage capacity.

## Picture storage capacity—standard compression

	Number of pictures				
	5.0 MP	4.4 MP (3:2)	4.0 MP	3.1 MP	1.8 MP
16 MB SD/MMC	9	11	12	15	24
32 MB internal memory	17	19	21	27	43
32 MB SD/MMC	19	22	24	30	48
64 MB SD/MMC	39	44	48	60	97
128 MB SD/MMC	79	88	97	121	195
256 MB SD/MMC	159	178	196	242	391
512 MB SD/MMC	319	356	392	485	783

## Picture storage capacity—fine compression

	Number of pictures				
	5.0 MP	4.4 MP (3:2)	4.0 MP	3.1 MP	1.8 MP
16 MB SD/MMC	4	5	5	7	12
32 MB internal memory	8	9	10	12	21
32 MB SD/MMC	9	10	11	14	24
64 MB SD/MMC	18	20	23	28	48
128 MB SD/MMC	37	41	46	57	97
256 MB SD/MMC	74	83	92	115	194
512 MB SD/MMC	149	167	185	231	389

## Video storage capacity

	Minutes/seconds of video	
	VGA (640 x 480)	QVGA (320 x 240)
<b>16 MB SD/MMC</b>	59 sec.	1 min. 53 sec.
<b>32 MB internal memory</b>	1 min. 47 sec.	3 min. 23 sec.
<b>32 MB SD/MMC</b>	1 min. 52 sec.	3 min. 46 sec.
<b>64 MB SD/MMC</b>	3 min. 59 sec.	7 min. 32 sec.
<b>128 MB SD/MMC</b>	7 min. 59 sec.	15 min. 4 sec.
<b>256 MB SD/MMC</b>	15 min. 58 sec.	30 min. 8 sec.
<b>512 MB SD/MMC</b>	31 min. 57 sec.	60 min. 17 sec.

## Power-saving features

If no action for	The camera	To turn it back on
1 minute	EVF/LCD screen turns off	Press the OK button.
8 minutes	Enters auto power off	Press any button or insert/remove card.

## Accessories

Item	Description	Where to buy
Schneider-Kreuznach Xenar 0.7X wide-angle lens	Expand your creativity and photographic options with the versatile 0.7X wide-angle lens.	<a href="http://www.kodak.com/go/z7590accessories">www.kodak.com/go/z7590accessories</a>
Kodak DX6490/Z7590 lens adapter	Allows you to add 55 mm screw-on lenses or filters	
Lens filter (black & white)	Neutral density filter 102. Reduces light by 2 f-stops (log density 0.6), 55 mm threads	
	Circular Polarizing filter (55 mm threads)	
Kodak 5-volt AC adapter	Easy way to extend battery life. Plug your camera in while downloading or viewing your pictures.	
Kodak performance series digital camera case	Stylish, but rugged, for Kodak EasyShare series digital cameras.	
Kodak EasyShare Li-Ion rechargeable battery—1700 mAh	Delivers outstanding capacity and charges up to 300 times in 3 hours or less.	
Kodak Li-Ion rapid battery charger kit	Includes six worldwide plugs ranging from 110–240 volts. Batteries sold separately.	
Check our Web site for the entire listing (batteries & chargers, memory cards, tripods, camera bags, travel kits, cartridge & photo paper kit, camera docks, printer docks, lenses, etc.)		

## Upgrading your software and firmware

Download the latest versions of the software included on the EasyShare software CD and the camera firmware (the software that runs on the camera). See [www.kodak.com/go/z7590downloads](http://www.kodak.com/go/z7590downloads).

## Additional care and maintenance

- If the camera has been subjected to inclement weather or you suspect water has gotten inside the camera, turn off the camera and remove the batteries and card. Allow all components to air-dry for at least 24 hours before using the camera again.
- Blow gently on the lens or camera screen to remove dust and dirt. Wipe gently with a soft, lint-free cloth or an untreated lens-cleaning tissue. Do not use cleaning solutions unless designed specifically for camera lenses. Do not allow chemicals, such as suntan lotion, to contact painted surfaces.
- Do not place your camera near equipment, such as electric motors. Electro-magnetic induction may corrupt pictures or cause camera malfunctions.
- Rapid changes in temperature can cause harmful condensation. Keep your camera in an airtight plastic bag and let it adjust to temperature before removing it from the bag.
- Service agreements are available in some countries. Contact a dealer of Kodak products for more information.
- For digital camera disposal or recycling information, contact your local authorities. In the US, visit the Electronics Industry Alliance Web site at [www.eiae.org](http://www.eiae.org) or the Kodak Web site at [www.kodak.com/go/z7590support](http://www.kodak.com/go/z7590support).

## Warranty

### Limited warranty

Kodak warrants Kodak digital cameras and accessories (excluding batteries) to be free from malfunctions and defects in both materials and workmanship for one year from the date of purchase.

Retain the original dated sales receipt. Proof of the date of purchase will be required with any request for warranty repair.

### Limited warranty coverage

**This limited warranty will be honored only within the geographical location that Kodak digital cameras and accessories were purchased.**

Kodak will REPAIR or REPLACE Kodak digital cameras and accessories if they fail to function properly during the warranty period, subject to any conditions and/or limitations stated herein. Such repair service will include all labor as well as any necessary adjustments and/or replacement parts. Such repair or replacement is the sole remedy under this warranty.

If replacement parts are used in making repairs, these parts may be remanufactured, or may contain remanufactured materials. If it is necessary to replace the entire product, it may be replaced with a remanufactured product.

### Limitations

Request for Warranty service will not be accepted without proof of date of purchase, such as a copy of the original dated Kodak digital camera or accessory sales receipt. (Always keep the original for your records.)

This warranty does not apply to the battery(s) used in digital cameras or accessories. This warranty does not cover circumstances beyond Kodak's control, nor problems caused by failure to follow the operating instructions in the Kodak digital cameras and accessories User's Guides.

THIS WARRANTY DOES NOT APPLY WHEN FAILURE IS DUE TO SHIPPING DAMAGE,

---

ACCIDENT, ALTERATION, MODIFICATION, UNAUTHORIZED SERVICE, MISUSE, ABUSE, USE WITH INCOMPATIBLE ACCESSORIES OR ATTACHMENTS, FAILURE TO FOLLOW KODAK'S OPERATION, MAINTENANCE OR REPACKING INSTRUCTIONS, FAILURE TO USE ITEMS SUPPLIED BY KODAK (SUCH AS ADAPTERS AND CABLES), OR CLAIMS MADE AFTER THE DURATION OF THIS WARRANTY.

Kodak makes no other express or implied warranty for this product. In the event that the exclusion of any implied warranty is ineffective under the law, the duration of the implied warranty will be one year from the purchase date.

The option of replacement is Kodak's only obligation. Kodak will not be responsible for any special, consequential or incidental damages resulting from the sale, purchase, or use of this product, regardless of the cause. Liability for any special, consequential or incidental damages (including but not limited to loss of revenue or profit, downtime costs, loss of the use of the equipment, cost of substitute equipment, facilities or services, or claims of your customers for such damages resulting from the purchase, use or failure of the product), regardless of cause or for breach of any written or implied warranty is expressly disclaimed and excluded here from.

## Your rights

Some states or jurisdictions do not allow exclusion or limitation of incidental or consequential damages, so the above limitation or exclusion may not apply to you. Some states or jurisdictions do not allow limitations on how long an implied warranty lasts, so the above limitation may not apply to you.

This warranty gives you specific rights, and you may have other rights which vary from state to state or by jurisdiction.

## Outside the United States and Canada

In countries other than the United States and Canada, the terms and conditions of this warranty may be different. Unless specific Kodak warranty is communicated to the purchaser in writing by a Kodak company, no warranty or liability exists beyond any minimum requirements imposed by law, even though defect, damage, or loss may be by negligence or other act.

## Regulatory compliance

### FCC compliance and advisory



Kodak EasyShare Z7590 zoom digital camera

This equipment has been tested and found to comply with the limits for a Class B digital device, pursuant to Part 15 of the FCC Rules. These limits are designed to provide reasonable protection against harmful interference in a residential installation.

This equipment generates, uses, and can radiate radio frequency energy and, if not installed or used in accordance with the instructions, may cause harmful interference to radio communications. However, there is no guarantee that interference will not occur in a particular installation.

If this equipment does cause harmful interference to radio or television reception, which can be determined by turning the equipment off and on, the user is encouraged to try to correct the interference by one or more of the following measures: 1) reorient or relocate the receiving antenna; 2) increase the separation between the equipment and the receiver; 3) connect the equipment to an outlet on a circuit different from that to which the receiver is connected; 4) consult the dealer or an experienced radio/TV technician for additional suggestions.

Any changes or modifications not expressly approved by the party responsible for compliance could void the user's authority to operate the equipment. Where shielded interface cables have been provided with the product or specified additional components or accessories elsewhere defined to be used with the installation of the product, they must be used in order to ensure compliance with FCC regulation.



## Canadian DOC statement

**DOC Class B Compliance**—This Class B digital apparatus complies with Canadian ICES-003.

**Observation des normes-Class B**—Cet appareil numérique de la classe B est conforme à la norme NMB-003 du Canada.

## VCCI Class B ITE

この装置は、情報処理装置等電波障害自主規制協議会（VCCI）の基準に基づくクラスB情報技術装置です。この装置は、家庭環境で使用することを目的としていますが、この装置がラジオやテレビジョン受信機に近接して使用されると、受信障害を引き起こすことがあります。  
取扱説明書に従って正しい取り扱いをして下さい。

English translation:

This is a Class B product based on the standard of the Voluntary Control Council for Interference from Information Technology Equipment (VCCI). If this is used near a radio or television receiver in a domestic environment, it may cause radio interference. Install and use the equipment according to the instruction manual.

## MPEG-4

Use of this product in any manner that complies with the MPEG-4 visual standard is prohibited, except for use by a consumer engaging in personal and non-commercial activities.

---

# Index

## A

- A/V out, 52
- A/V out (for TV viewing)
  - connection location, ii
- about this camera, 38
- AC adapter, 3
- accessories
  - battery, 3
  - buying, 74
  - camera, 82
  - external flash, 27
  - printer dock, 63
  - SD or MMC card, 8
- AF control, 34
- album, 35
- albums, tagging pictures for, 39, 50
- aperture priority, 18
- aperture, PASM mode, 21
- auto, 17
  - flash, 23
  - focus framing marks, 11
  - power-down, 81

## B

- backlight, 21
- battery
  - charge via charger, 1
  - expected life, 2
  - extending life, 3
  - inserting, 2
  - safety, 4
- battery door, iv

- beach, 20
- bracketing interval, 32
- burst first/last button, iv
- burst, using, 29
- button
  - burst, 29
  - close-up/landscape, 27
  - delete, 15
  - exposure bracketing, 28
  - flash/status, 23
  - On/Off, 5
  - on/off, iii
  - review, 45
  - share, iii, 56
  - zoom, 16

## C

- cable
  - audio/video, 52
  - USB, 62
- camera accessories, 82
- camera dock, 3
- camera screen
  - reviewing pictures, 45
  - reviewing videos, 45
- Canadian compliance, 87
- caring for your camera, 83
- charging
  - battery via charger, 1
  - lights, battery charger, 1
- children, 21
- clock, setting, 6

close-up  
  scenes, 27  
close-up button, iv  
close-up pictures, 28  
color mode, 34  
compression, 31  
computer  
  connecting camera, 62  
  transfer to, 62  
copy pictures  
  card to memory, 53  
  memory to card, 53  
  to computer via USB cable, 62  
custom, 18  
custom exposure mode, 30  
customer support, 75

## D

date setting, 6  
DC-In (5V)  
  connection location, ii  
delete button, iii  
deleting  
  during quickview, 15  
  from internal memory, 48  
  from MMC/SD Card, 48  
digital zoom, 36  
digital zoom, using, 16  
displaying slide show, 51  
disposal, recycling, 83  
distant scenes, 27  
dock  
  printer, 63  
dock compatibility, 66

dock connector, iv  
downloading pictures, 62

## E

EasyShare software, 54  
emailing pictures, videos, 58  
er, 81  
EVF/LCD toggle button, iii  
exposure  
  compensation, PASM mode, 21  
  exposure bracketing button, iv  
  exposure metering, 33  
external flash, 27  
external flash connector location, ii  
external video device  
  viewing pictures, videos, 52  
external-flash-connector cover, ii

## F

favorites, 18  
  removing, 61  
  settings, 60  
  tagging, 59  
FCC compliance, 86  
fireworks, 20  
firmware, upgrading, 83  
first burst/last burst button, iv  
flash  
  compensation, PASM mode, 27  
  external, 27  
  off, 27  
  rear-curtain sync, 27  
  red-eye, 27  
  settings, 23

flash button, iv  
flip-up flash, i, iv  
flower, 20  
focus framing marks, 11  
focus zone, 33  
format, 38

## H

help  
    troubleshooting, 67  
    web links, 74  
histogram, 12

## I

icons, mode dial, 17  
image storage, 35  
inserting  
    battery, 2  
    SD or MMC card, 8  
installing software, 55  
internal memory  
    storage capacity, 79

## J

jog dial, i  
joystick, iii

## K

Kodak EasyShare software  
    installing, 55  
    upgrading, 83  
Kodak web sites, 74

## L

landscape, 19, 27

landscape button, iv  
language, 37  
LCD (Liquid Crystal Display) screen, iii  
LCD/EVF toggle button, iii  
lens, i  
    cleaning lens, 83  
light  
    jog dial, i  
    power ring, iii, 72  
locator for EasyShare camera dock or  
    printer dock, iv

## M

Macintosh  
    installing software on, 55  
macro mode, 44  
magnify picture, 48  
maintenance, camera, 83  
manner, 20  
manual, 18  
memory  
    inserting card, 8  
menu button, iii  
microphone, i  
mode dial, iii, 17  
mode light, iii  
modes  
    aperture priority, 18  
    auto, 17  
    backlight, 21  
    beach, 20  
    children, 21  
    custom, 18  
    custom exposure, 30

favorites, 18  
fireworks, 20  
flower, 20  
landscape, 19  
manner, 20  
manual, 18  
night landscape, 20  
night portrait, 19  
party, 20  
portrait, 19  
program, 17  
SCN, 19  
self-portrait, 20  
shutter priority, 18  
snow, 20  
text, 20

**N**

neckstrap post, iii  
night landscape, 20  
night portrait, 19

**O**

OK button, iii  
on/off button, iii  
online prints, ordering, 63  
open flash lever, iv  
optical zoom, 16  
orientation sensor, 37

**P**

party, 20  
PASM mode  
    screen options, 21  
PictBridge printer, 64

picture size, 31  
picture status, iii  
pictures  
    copying, 53  
    deleting, 48  
    emailing tagged, 58  
    magnifying, 48  
    printing tagged, 57  
    reviewing, 45  
    storage capacity, 79  
    tagging, 50  
    taking, modes, 17  
    transfer via USB cable, 62

picture-taking tips, 40  
portrait, 19

**power**

auto off, 81  
camera, 5  
ring, iii, 72  
switch, iii

printer dock, 3, 63

**printing**

from a card, 63  
optimizing printer, 74  
order online, 63  
PictBridge, 64  
tagged pictures, 63  
    with EasyShare printer dock, 63

program, 17

protecting pictures, videos, 49

**Q**

quickview, 36  
using, 15

## R

- ReadMe file, 67
- rear-curtain-flash sync, 25
- recycling, disposal, 83
- red-eye, flash, 23
- regulatory information, 86
- removing favorites, 61
- reset to default, 34
- review button, iii, 45
- reviewing pictures
  - as you take them, 15
  - camera screen, 45
  - deleting, 48
  - magnifying, 48
  - slide show, 51
- reviewing videos
  - camera screen, 45
  - deleting, 48
  - slide show, 51
- running slide show, 51

## S

- safety
  - battery, 4
- SCN, 19
- SD or MMC card
  - inserting, 8
  - storage capacities, 79
- SD/MMC card
  - printing from, 63
- SD/MMC card slot, ii
- self-portrait, 20
- self-timer, 30
  - pictures/videos, 38

- self-timer/video light, i
- service and support
  - telephone numbers, 75
- setting
  - AF control, 34
  - album, 35
  - bracketing interval, 32
  - color mode, 34
  - compression, 31
  - date and time, 6
  - digital zoom, 36
  - exposure metering, 33
  - flash, 23
  - focus zone, 33
  - image storage, 35
  - language, 37
  - picture size, 31
  - picture taking mode, 17
  - quickview, 36
  - self-timer, 30, 38
  - sharpness, 34
  - sound themes, 37
  - video length, 35
  - video out, 37
  - white balance, 32
- share button, iii, 56
- sharpness, 34
- shutoff, auto, 81
- shutter
  - self-timer delay, 38
- shutter button, i, iv
- shutter priority, 18
- shutter speed, PASM mode, 21
- shutter, problems, 68

sleep mode, 81  
slide show  
    problems, 70  
    running, 51  
snow, 20  
software  
    installing, 55  
    upgrading, 83  
sound themes, 37  
speaker, iv  
specifications, 76  
status button, iii  
storage capacity, 79  
support, technical, 75

## T

tagging, 39  
    favorites, 59  
    for email, 58  
    for print, 57  
    when to tag, 56  
tagging pictures  
    for albums, 39, 50  
telephone support, 75  
television, slide show, 52  
text, 20  
time, setting, 6  
timer, shutter delay, 38  
tips  
    battery guidelines, 3  
    care & maintenance, 83  
    picture-taking, 40  
    ReadMe file, 67  
transfer, via USB cable, 62

trash can, deleting, 15  
tripod socket, iv  
troubleshooting, 67  
turning camera on and off, 5

## U

upgrading software, firmware, 83  
URLs, Kodak web sites, 74  
USB (universal serial bus)  
    connection location, ii  
    transferring pictures, 62  
USB port/DC-in/A/V-out cover, ii

## V

VCCI compliance, 87  
video length, 35  
video out, 37  
videos  
    copying, 53  
    deleting, 48  
    emailing tagged, 58  
    reviewing, 45  
    storage capacities, 79  
    transfer to computer, 62  
    viewing, 45  
viewing picture  
    after taking, 15, 45  
    magnified, 48

## W

warranty, 84  
white balance, 32  
Windows computers  
    installing software, 55

**Z**

zoom

digital, 16

optical, 16

zoom lever, iii